

CALATHEA SUSPENSION

D141238-

base number Color Finish Finish
 Temperature Options Options

- To build a product code in our configurator select the specify button on the base model # product page
- To build a manual product code on this datasheet choose from the options listed below in blue font and add the suffix to the base model #

GENERAL

Series: Vegetal
 Subseries: Calathea
 Brand: Cangini & Tucci
 Division: Design
 Mounting Type: Suspension
 Mounting Location: Ceiling
 Subcategory: Pendant

PHYSICAL

Shape: Abstract
 Diameter (mm): 180
 Diameter (in): 7 1/16
 Height (mm): 220
 Height (in): 8 11/16
 Max. Overall Height (mm): 2220
 Max. Overall Height (in): 87 3/8
 Light Distribution: Omnidirectional
 Fixture Finish: [AMB](#) / [GRN](#) / [PNK](#) / [RUB](#) / [SKB](#) / [SMK](#) / [TOB](#) / [TRA](#)
 Holder Finish: [SGD](#) / [SBK](#)
 Fixture Material: Glass / Metal
 Cable Details: 2,000mm Transparent cable

ELECTRICAL

Lamp Type: LED (Zhaga Standard)
 Input Wattage (W): 4.2
 Dimming: Non-Dimmable
 Driver Included: Yes
 Driver Location: Integrated
 Driver Class: Class 2
 Input Voltage (V): 120 - 277
 Constant Current (mA): 350mA
 Upon Request: Phase Dimming (120Vac only) / 0-10V Dimming

LED

Color Temperature (°K): [2700](#) / [3000](#)
 Nominal Lumen (lm): 460 / 500
 CRI: >90 CRI
 Lamp Life (hrs): 50000

OPTICAL

RATINGS AND CERTIFICATIONS

Certified By: Certified for North American Standards
 IP rating: IP20

PROJECT
TYPE
SPECIFIER
QUANTITY
DATE



CALATHEA SUSPENSION

D141238-

PROJECT

TYPE

SPECIFIER

QUANTITY

DATE



D

FICUS SUSPENSION

D141239-

base number Color Finish Finish
Temperature Options Options

- To build a product code in our configurator select the specify button on the base model # product page
- To build a manual product code on this datasheet choose from the options listed below in blue font and add the suffix to the base model #

GENERAL

Series: Vegetal
 Subseries: Ficus
 Brand: Cangini & Tucci
 Division: Design
 Mounting Type: Suspension
 Mounting Location: Ceiling
 Subcategory: Pendant

PHYSICAL

Shape: Abstract
 Diameter (mm): 180
 Diameter (in): 7 1/8
 Height (mm): 220
 Height (in): 8 11/16
 Max. Overall Height (mm): 2220
 Max. Overall Height (in): 87 3/8
 Light Distribution: Omnidirectional
 Fixture Finish: [AMB / GRN / PNK / RUB / SKB / SMK / TOB / TRA](#)
 Holder Finish: SGD / SBK
 Fixture Material: Glass / Metal
 Cable Details: 2,000mm Transparent cable

ELECTRICAL

Lamp Type: LED (Zhaga Standard)
 Input Wattage (W): 4.2
 Dimming: Non-Dimmable
 Driver Included: Yes
 Driver Location: Integrated
 Driver Class: Class 2
 Input Voltage (V): 120 - 277
 Constant Current (mA): 350mA
 Upon Request: Phase Dimming (120Vac only) / 0-10V Dimming

LED

Color Temperature (°K): [2700 / 3000](#)
 Nominal Lumen (lm): 460 / 500
 CRI: >90 CRI
 Lamp Life (hrs): 50000

OPTICAL

RATINGS AND CERTIFICATIONS

Certified By: Certified for North American Standards
 IP rating: IP20

PROJECT
TYPE
SPECIFIER
QUANTITY
DATE



FICUS SUSPENSION

D141239-

PROJECT

TYPE

SPECIFIER

QUANTITY

DATE



D

PROJECT
TYPE
SPECIFIER
QUANTITY
DATE

PILEA SUSPENSION

D141240-

base number	Color Temperature	Finish Options	Finish Options
-------------	----------------------	-------------------	-------------------

- To build a product code in our configurator select the specify button on the base model # product page
- To build a manual product code on this datasheet choose from the options listed below in blue font and add the suffix to the base model #

GENERAL

Series: Vegetal
Subseries: Pilea
Brand: Cangini & Tucci
Division: Design
Mounting Type: Suspension
Mounting Location: Ceiling
Subcategory: Pendant

PHYSICAL

Shape: Abstract
Diameter (mm): 250
Diameter (in): 9 ¹³ / ₁₆
Height (mm): 220
Height (in): 8 ¹¹ / ₁₆
Max. Overall Height (mm): 2220
Max. Overall Height (in): 87 ³ / ₈
Light Distribution: Omnidirectional
Fixture Finish: AMB / GRN / PNK / RUB / SKB / SMK / TOB / TRA
Holder Finish: SGD / SBK
Fixture Material: Glass / Metal
Cable Details: 2,000mm Transparent cable

ELECTRICAL

Lamp Type: LED (Zhaga Standard)
Input Wattage (W): 4.2
Dimming: Non-Dimmable
Driver Included: Yes
Driver Location: Integrated
Driver Class: Class 2
Input Voltage (V): 120 - 277
Constant Current (mA): 350mA
Upon Request: Phase Dimming (120Vac only) / 0-10V Dimming

LED

Color Temperature (°K): 2700 / 3000
Nominal Lumen (lm): 460 / 500
CRI: >90 CRI
Lamp Life (hrs): 50000

OPTICAL

RATINGS AND CERTIFICATIONS

Certified By: Certified for North American Standards
IP rating: IP20



PILEA SUSPENSION

D141240-

PROJECT

TYPE

SPECIFIER

QUANTITY

DATE

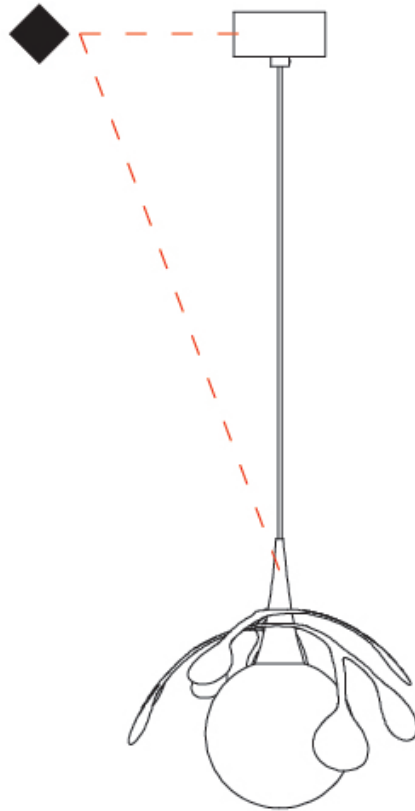

D

PALMA SUSPENSION

D141241-

base number Color Finish Finish
 Temperature Options Options

- To build a product code in our configurator select the specify button on the base model # product page
- To build a manual product code on this datasheet choose from the options listed below in blue font and add the suffix to the base model #

GENERAL

Series: Vegetal
 Subseries: Palma
 Brand: Cangini & Tucci
 Division: Design
 Mounting Type: Suspension
 Mounting Location: Ceiling
 Subcategory: Pendant

PHYSICAL

Shape: Abstract
 Diameter (mm): 450
 Diameter (in): 17 ¹¹/₁₆
 Height (mm): 1000
 Height (in): 39 ³/₈
 Max. Overall Height (mm): 3000
 Max. Overall Height (in): 118 ⁷/₈
 Light Distribution: Omnidirectional
 Fixture Finish: [AMB](#) / [GRN](#) / [PNK](#) / [RUB](#) / [SKB](#) / [SMK](#) / [TOB](#) / [TRA](#)
 Holder Finish: SGD / SBK
 Fixture Material: Glass / Metal
 Cable Details: 2,000mm Transparent cable

ELECTRICAL

Lamp Type: LED (Zhaga Standard)
 Input Wattage (W): 6
 Dimming: Non-Dimmable
 Driver Included: Yes
 Driver Location: Integrated
 Driver Class: Class 2
 Input Voltage (V): 120 - 277
 Constant Current (mA): 500mA

LED

Color Temperature (°K): [2700](#) / [3000](#)
 Nominal Lumen (lm): 866
 CRI: >90 CRI
 Lamp Life (hrs): 50000

OPTICAL

RATINGS AND CERTIFICATIONS

Certified By: Certified for North American Standards
 IP rating: IP20



PALMA SUSPENSION

D141241-

PROJECT

TYPE

SPECIFIER

QUANTITY

DATE



D

PROJECT
TYPE
SPECIFIER
QUANTITY
DATE

VEGETAL - 7 LIGHT LINEAR SUSPENSION

D141265-

base number Color Finish
 Temperature Options

- To build a product code in our configurator select the specify button on the base model # product page
- To build a manual product code on this datasheet choose from the options listed below in blue font and add the suffix to the base model #

GENERAL

Series: Vegetal
 Subseries: Vegetal - 7 Light Linear
 Brand: Cangini & Tucci
 Division: Design
 Mounting Type: Suspension
 Mounting Location: Ceiling
 Subcategory: Pendant

PHYSICAL

Shape: Abstract
 Length (mm): 1300
 Length (in): 51 ³/₁₆
 Width (mm): 400
 Width (in): 15 ³/₄
 Height (mm): 220
 Height (in): 8 ¹¹/₁₆
 Max. Overall Height (mm): 2220
 Max. Overall Height (in): 87 ³/₈
 Light Distribution: Omnidirectional
 Fixture Finish: [AMB](#) / [GRN](#) / [PNK](#) / [RUB](#) / [SKB](#) / [SMK](#) / [TOB](#) / [TRA](#)
 Holder Finish: [SGD](#) / [SBK](#)
 Accent Finish: [CHR](#) / [MWH](#) / [MBK](#) / [BCR](#)
 Fixture Material: Glass / Metal
 Cable Details: 2,000mm Transparent cable

ELECTRICAL

Lamp Type: LED (Zhaga Standard)
 Input Wattage (W): 29.4
 Dimming: Non-Dimmable
 Driver Included: Yes
 Driver Location: Integrated
 Driver Class: Class 2
 Input Voltage (V): 120 - 277
 Constant Current (MA): 350mA
 Upon Request: Phase Dimming (120Vac only) / 0-10V Dimming

LED

Color Temperature (°K): [2700](#) / [3000](#)
 Nominal Lumen (lm): 3220 / 3500
 CRI: >90 CRI
 Lamp Life (hrs): 50000

OPTICAL

RATINGS AND CERTIFICATIONS

Certified By: Certified for North American Standards
 IP rating: IP20

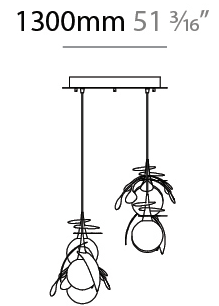
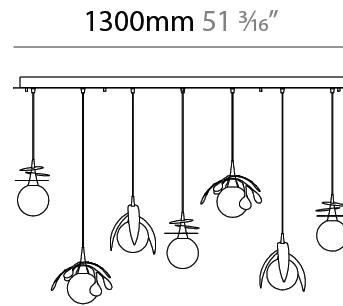

VEGETAL - 7 LIGHT LINEAR SUSPENSION

D141265-

PROJECT

TYPE

SPECIFIER

QUANTITY

DATE

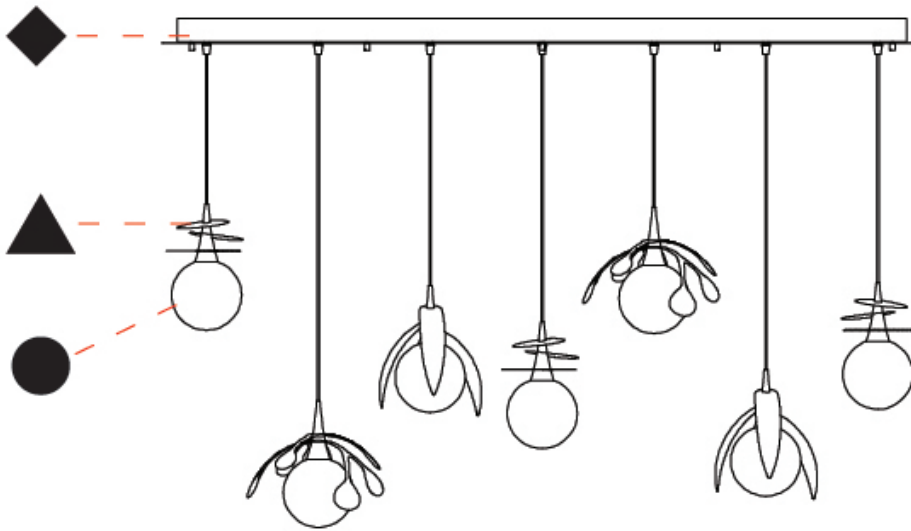

D

PROJECT	
TYPE	
SPECIFIER	
QUANTITY	
DATE	

VEGETAL - 3 LIGHT CLUSTER SUSPENSION

D141266-

base number Color Finish
 Temperature Options

- To build a product code in our configurator select the specify button on the base model # product page
- To build a manual product code on this datasheet choose from the options listed below in blue font and add the suffix to the base model #

GENERAL

Series: Vegetal
 Subseries: Vegetal - 3 Light Cluster
 Brand: Cangini & Tucci
 Division: Design
 Mounting Type: Suspension
 Mounting Location: Ceiling
 Subcategory: Pendant

PHYSICAL

Shape: Abstract
 Diameter (mm): 430
 Diameter (in): 16 ¹⁵/₁₆
 Height (mm): 220
 Height (in): 8 ¹¹/₁₆
 Max. Overall Height (mm): 2220
 Max. Overall Height (in): 87 ³/₈
 Light Distribution: Omnidirectional
 Fixture Finish: [AMB](#) / [GRN](#) / [PNK](#) / [RUB](#) / [SKB](#) / [SMK](#) / [TOB](#) / [TRA](#)
 Holder Finish: [SGD](#) / [SBK](#)
 Accent Finish: [CHR](#) / [MWH](#) / [MBK](#) / [BCR](#)
 Fixture Material: Glass / Metal
 Cable Details: 2,000mm Transparent cable

ELECTRICAL

Lamp Type: LED (Zhaga Standard)
 Input Wattage (W): 12.6
 Dimming: Non-Dimmable
 Driver Included: Yes
 Driver Location: Integrated
 Driver Class: Class 2
 Input Voltage (V): 120 - 277
 Constant Current (MA): 500mA
 Upon Request: Phase Dimming (120Vac only) / 0-10V Dimming

LED

Color Temperature (°K): [2700](#) / [3000](#)
 Nominal Lumen (lm): 1380 / 1500
 CRI: >90 CRI
 Lamp Life (hrs): 50000

OPTICAL

RATINGS AND CERTIFICATIONS

Certified By: Certified for North American Standards
 IP rating: IP20

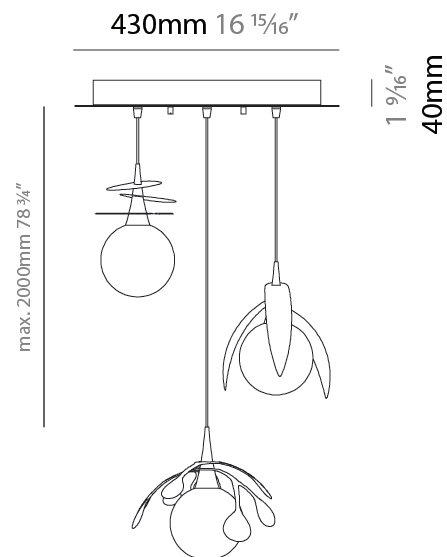

VEGETAL - 3 LIGHT CLUSTER SUSPENSION

D141266-

PROJECT	_____
TYPE	_____
SPECIFIER	_____
QUANTITY	_____
DATE	_____

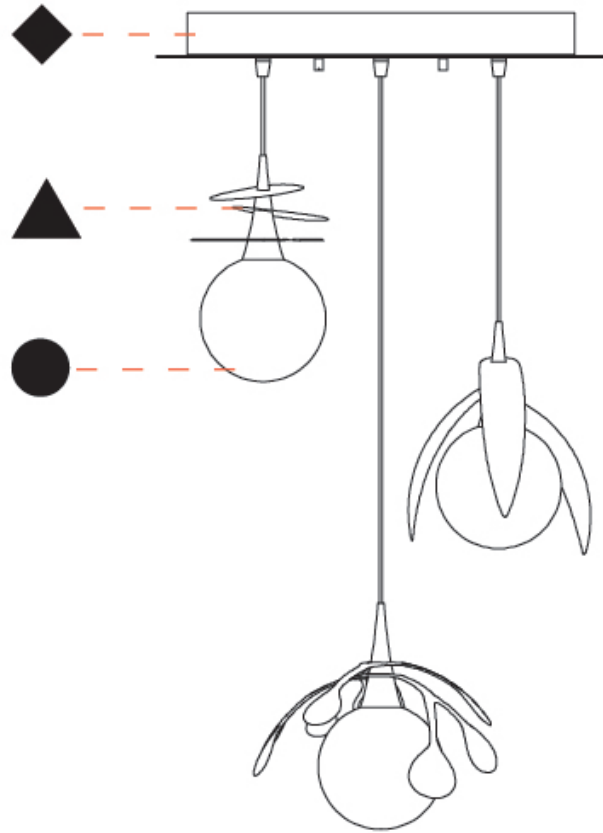

D

VEGETAL - 3 LIGHT LINEAR SUSPENSION

D141267-

base number Color Finish
 Temperature Options

- To build a product code in our configurator select the specify button on the base model # product page
- To build a manual product code on this datasheet choose from the options listed below in blue font and add the suffix to the base model #

GENERAL

Series: Vegetal
 Subseries: Vegetal - 3 Light Linear
 Brand: Cangini & Tucci
 Division: Design
 Mounting Type: Suspension
 Mounting Location: Ceiling
 Subcategory: Pendant

PHYSICAL

Shape: Abstract
 Length (mm): 900
 Length (in): 35 7/16
 Height (mm): 220
 Height (in): 8 11/16
 Max. Overall Height (mm): 2220
 Max. Overall Height (in): 87 3/8
 Light Distribution: Omnidirectional
 Fixture Finish: AMB / GRN / PNK / RUB / SKB / SMK / TOB / TRA
 Holder Finish: SGD / SBK
 Accent Finish: CHR / MWH / MBK / BCR
 Fixture Material: Glass / Metal
 Cable Details: 2,000mm Transparent cable

ELECTRICAL

Lamp Type: LED (Zhaga Standard)
 Input Wattage (W): 12.6
 Dimming: Non-Dimmable
 Driver Included: Yes
 Driver Location: Integrated
 Driver Class: Class 2
 Input Voltage (V): 120 - 277
 Constant Current (MA): 350mA
 Upon Request: Phase Dimming (120Vac only) / 0-10V Dimming

LED

Color Temperature (°K): 2700 / 3000
 Nominal Lumen (lm): 1380 / 1500
 CRI: >90 CRI
 Lamp Life (hrs): 50000

OPTICAL

RATINGS AND CERTIFICATIONS

Certified By: Certified for North American Standards
 IP rating: IP20

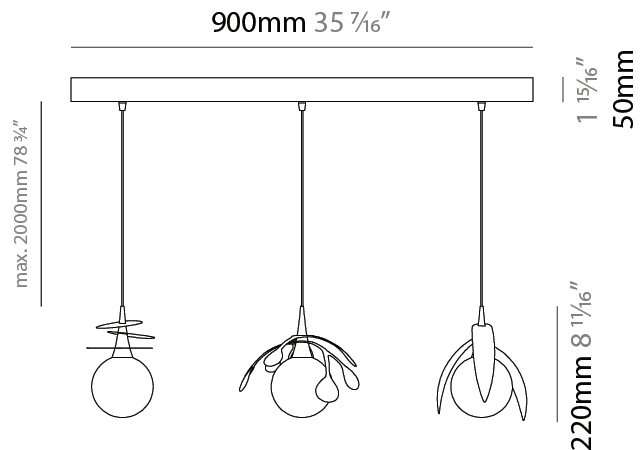

VEGETAL - 3 LIGHT LINEAR SUSPENSION

D141267-

PROJECT	_____
TYPE	_____
SPECIFIER	_____
QUANTITY	_____
DATE	_____

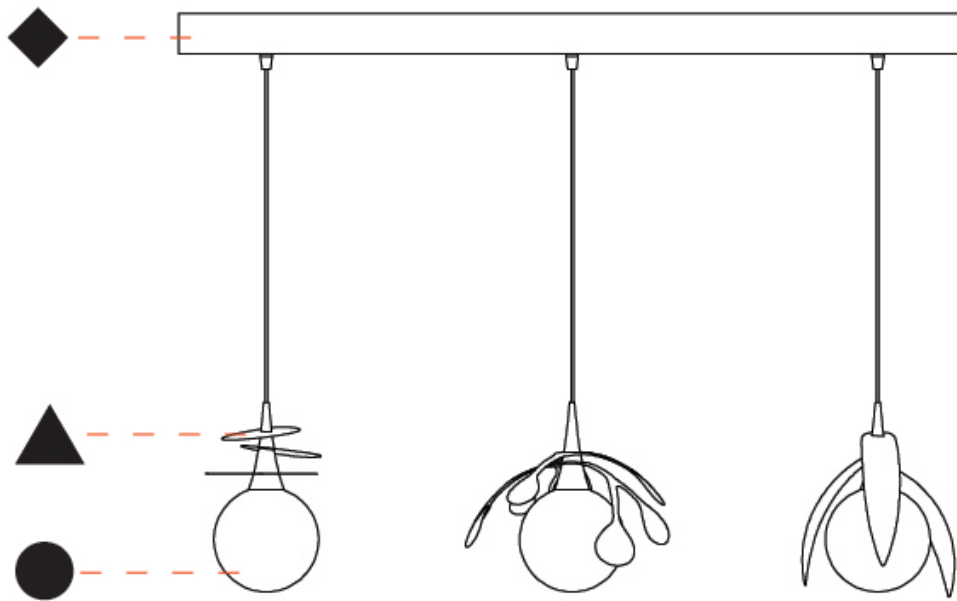

D

VEGETAL COLOR FINISH CHART

PROJECT _____
TYPE _____
SPECIFIER _____
QUANTITY _____
DATE _____

Fixture Finish

Amber - AMB



Green - GRN



Pink - PNK



Ruby - RUB



Sky Blue - SKB



Smoke - SMK



Tobacco - TOB



Transparent - TRA



Holder Finish

Satin Gold - SGD

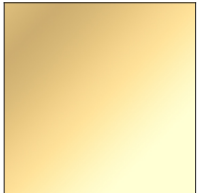

Satin Black Nickel - SBK



CALATHEA, FICUS, PILEA, PALMA, VEGETAL - 7 LIGHT LINEAR, VEGETAL - 3 LIGHT LINEAR, VEGETAL - 3 LIGHT CLUSTER

SUSPENSION

COLOR FINISH CHART

Accent Finish

Chrome - CHR



Matte White - MWH

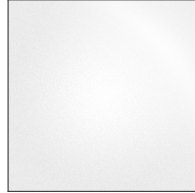

Matte Black - MBK



Brushed Chrome - BCR

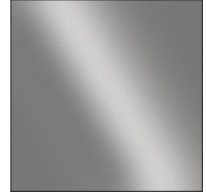

Digital: Not all screens are calibrated the same, and therefore, colors will appear differently between screens.

Physical: When texture is involved, there will be variations in color, character and tone within a product series and between product families.



PROJECT	
TYPE	
SPECIFIER	
QUANTITY	
DATE	

LEGEND

floor-mounted	pivotal	special LED (upon request) RGB, RGBW, tunable, gold+, meat+, art+, fashion+
wall and ceiling: recessed and surface mounted	rotating	warm dim / natural dimming LED
ceiling-mounted and wall-mounted	illuminate tilted	rechargeable battery powered
wall-mounted	color of suspension cable	fixture with natural vivid LED (upon request)
omni-directional light distribution	length of suspension cable	color rendering index
direct light distribution	reflector degree selection	color temperature
direct/indirect light distribution	super spot	lumen (luminous flux)
indirect light distribution	lens	efficacy (lumens per watt)
asymmetric light distribution	lens pack	Unified Glare Rating (UGR) range from 5-40
aura light distribution	shine ring	marine grade (AISI 316 stainless steel)
round wall or ceiling cut-out	integrated shine ring with diffuser	walk on
square wall or ceiling cut-out	free individual colors 01-29	drive on
the supplied jig specifies the cutout dimensions	individual colors: 00 (free of charge), 01-25 (extra charge)	Dark Sky Compliance
minimum distance (meters) lamp - object	luminaire part to be colored (F1)	Americans with Disabilities Act (less than 4" off the wall located between 27"-84" from floor)
recessed depth	luminaire part to be colored (F2)	lamp protected against explosion
ceiling thickness in mm	luminaire part to be colored (F3)	blown glass using traditional methods by master glass blower
ceiling thickness selection	luminaire part to be colored (F4)	acoustic material
dimmable DP (phase), DV (0-10V), DD (dali), DS (step-dim)	luminaire part to be colored (F5)	protection class I, protection insulation
included or excluded LED driver/transformer/control gear	color of 3-circuit adaptor	protection class II, protection insulation
separately switchable	indirect diffuser	ETL Certified to UL and CSA Standards
sensor	direct diffuser	UL Certified to UL and CSA Standards
remote control	ball-proof (upon request)	CSA Certified to UL and CSA Standards
available upon request	accessory	Certified for North American Standards

IP RATING

IP20	protected against ingress of solid bodies greater than 12.5mm (finger)
IP33	protected against ingress of solid bodies greater than 2.5mm protected against sprays of water up to 60 degrees from the vertical (rain)
IP40	protected against ingress of solid bodies greater than 1mm (wire) no protection against the ingress of moisture
IP43	protected against ingress of solid bodies greater than 1mm (wire) protected against sprays of water up to 60 degrees from the vertical (rain)
IP44	protected against ingress of solid bodies greater than 1mm (wire) protected against water splashed from all directions
IP54	protected against limited ingress of dust (wet rooms/covered outdoor areas) protected against water splashed from all directions
IP65	protected against ingress of dust protected against jets of water
IP66	protected against ingress of dust protected against powerful jets of water or heavy seas
IP67	protected against ingress of dust protected against immersion of water between 15cm - 1m for 30 minutes
IP68	protected against ingress of dust protected against immersion of water under pressure for long periods

IK RATING

IK01	protected against 0.14 joules impact (equivalent to 0.25kg mass dropped from 56mm above the surface)
IK02	protected against 0.2 joules impact (equivalent to 0.25kg mass dropped from 80mm above the surface)
IK03	protected against 0.35 joules impact (equivalent to 0.25kg mass dropped from 140mm above the surface)
IK04	protected against 0.5 joules impact (equivalent to 0.25kg mass dropped from 200mm above the surface)
IK05	protected against 0.7 joules impact (equivalent to 0.25kg mass dropped from 280mm above the surface)
IK06	protected against 1 joules impact (equivalent to 0.25kg mass dropped from 400mm above the surface)
IK07	protected against 2 joules impact (equivalent to 0.5kg mass dropped from 400mm above the surface)
IK08	protected against 5 joules impact (equivalent to 1.7kg mass dropped from 300mm above the surface)
IK09	protected against 10 joules impact (equivalent to 5.0kg mass dropped from 200mm above the surface)
IK10	protected against 20 joules impact (equivalent to 5.0kg mass dropped from 400mm above the surface)