

PROJECT	
TYPE	
SPECIFIER	
QUANTITY	
DATE	

VERA SURFACE

D42063- -

base number Color Finish
 Temperature Options

- To build a product code in our configurator select the specify button on the base model # product page
- To build a manual product code on this datasheet choose from the options listed below in blue font and add the suffix to the base model #

GENERAL

Series: Vera
 Partner: Icone
 Division: Design
 Installation: Surface
 Product Type: Wall Surface
 Mounting Location: Ceiling
 Light Distribution: Adjustable

PHYSICAL

Shape: Round
 Diameter (mm): 210
 Diameter (in): 8 ¼
 Height (mm): 210
 Depth (mm): 70
 Height (in): 8 ¼
 Depth (in): 2 ¾
 Extension (mm): 270
 Extension (in): 10 ⅝

Fixture Finish: [GLF_WHI](#) / [GLF_RUS](#) / [CLF_BLK](#) / [WHI_ALU](#) / [WHI_COP](#) / [WHI_WHI](#) / [WHI_BRA](#) / [WHI_RUS](#) / [WHI_BLK](#)

Fixture Material: Aluminum

ELECTRICAL

Lamp Type: LED
 Input Wattage (W): 16
 Total Output Wattage (W): 13.5
 Dimming: Non-Dimmable / 0-10V Dimming
 Driver Included: Yes
 Driver Location: Integrated
 Driver Type: Constant Current - 120Vac
 Driver Class: Class 2
 Input Voltage (V): 120
 Constant Current (MA): 700

LED

Color Temperature (°K): 2700 / 3000
 Nominal Lumen (lm): 2100
 CRI: >90 CRI
 Lamp Life (hrs): 50000

OPTICAL

RATINGS AND CERTIFICATIONS

Certified By: Certified for North American Standards
 IP rating: IP20

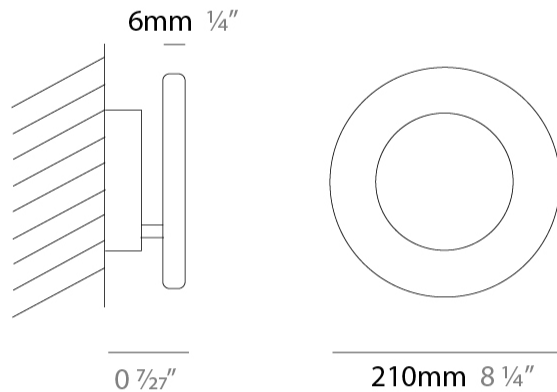

D42063-

PROJECT	_____
TYPE	_____
SPECIFIER	_____
QUANTITY	_____
DATE	_____

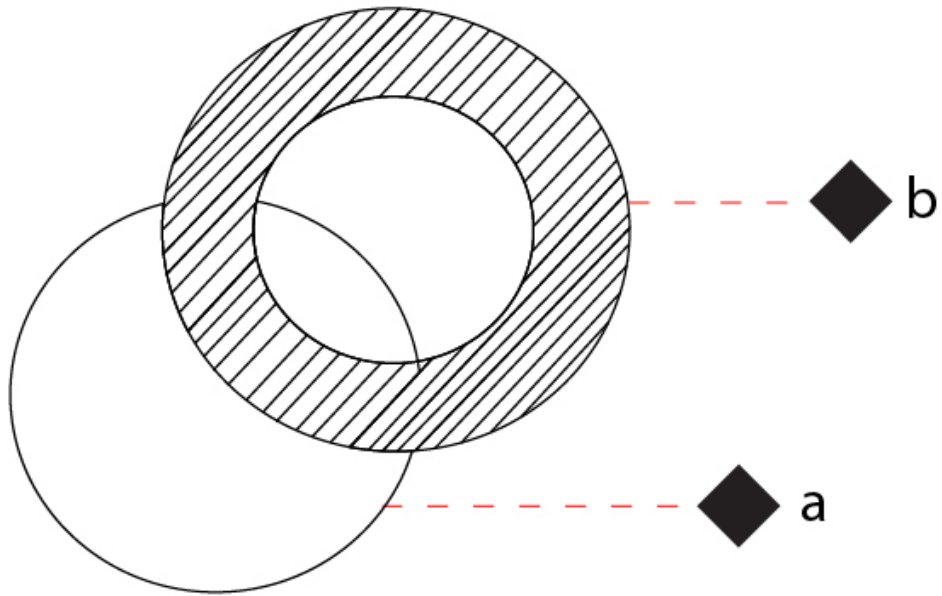

D

PROJECT	_____
TYPE	_____
SPECIFIER	_____
QUANTITY	_____
DATE	_____

VERA SURFACE

D42064- _____ - _____
 base number Color Finish
 Temperature Options

- To build a product code in our configurator select the specify button on the base model # product page
- To build a manual product code on this datasheet choose from the options listed below in blue font and add the suffix to the base model #

GENERAL

Series: Vera
 Partner: Icone
 Division: Design
 Installation: Surface
 Product Type: Wall Surface
 Mounting Location: Ceiling
 Light Distribution: Adjustable

PHYSICAL

Shape: Round
 Diameter (mm): 260
 Diameter (in): 10 1/4
 Height (mm): 260
 Height (in): 10 1/4
 Extension (mm): 320
 Extension (in): 12 5/8
 Fixture Finish: [GLF_WHI](#) / [GLF_RUS](#) / [CLF_BLK](#) / [WHI_ALU](#) / [WHI_COP](#) / [WHI_WHI](#) / [WHI_BRA](#) / [WHI_RUS](#) / [WHI_BLK](#)
 Fixture Material: Aluminum

ELECTRICAL

Lamp Type: LED
 Total Output Wattage (W): 16.8
 Dimming: Non-Dimmable / 0-10V Dimming
 Driver Included: Yes
 Driver Location: Integrated
 Driver Type: Constant Current - Universal
 Driver Class: Class 2
 Input Voltage (V): 120 - 277
 Constant Current (MA): 700

LED

Color Temperature (°K): [2700](#) / [3000](#)
 Nominal Lumen (lm): 2598
 CRI: >90 CRI
 Lamp Life (hrs): 50000

OPTICAL

RATINGS AND CERTIFICATIONS

Certified By: Certified for North American Standards
 IP rating: IP20

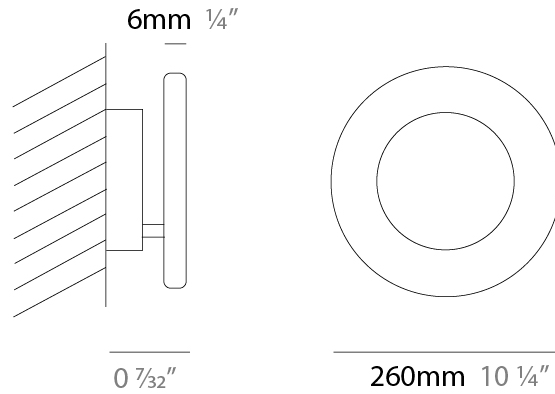

D42064-

PROJECT	_____
TYPE	_____
SPECIFIER	_____
QUANTITY	_____
DATE	_____

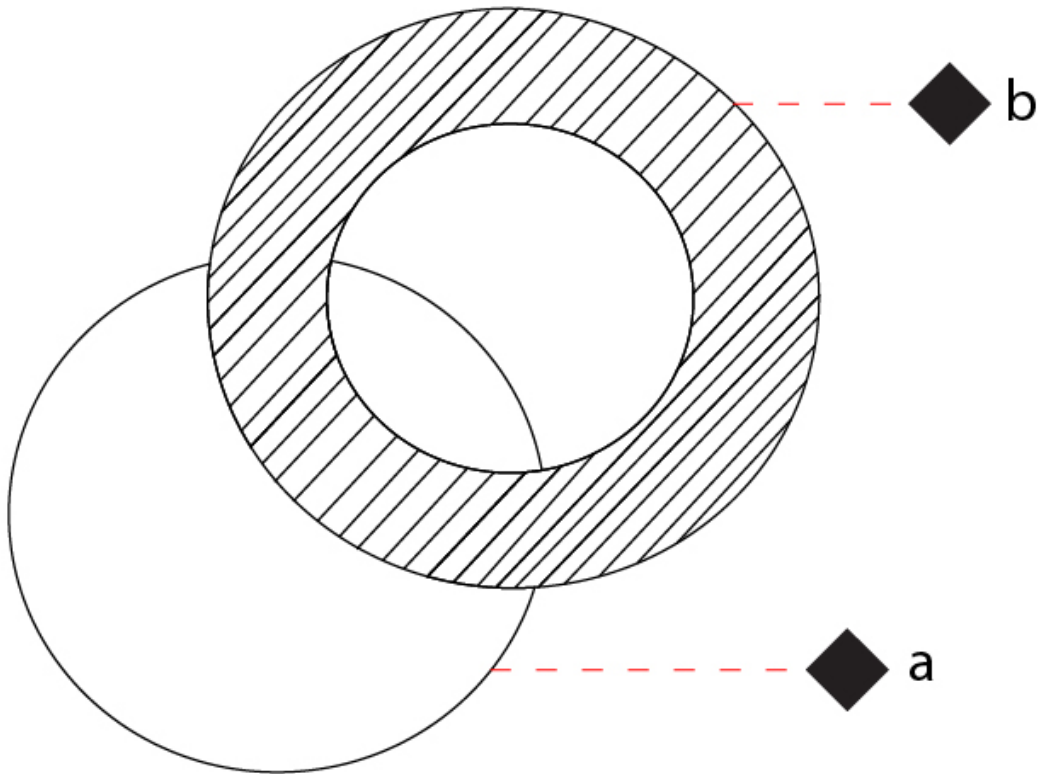

D

PROJECT	
TYPE	
SPECIFIER	
QUANTITY	
DATE	

VERA SURFACE

D42065-

base number
 Color Temperature Finish Options

- To build a product code in our configurator select the specify button on the base model # product page
- To build a manual product code on this datasheet choose from the options listed below in blue font and add the suffix to the base model #

GENERAL

Series: Vera
 Partner: Icone
 Division: Design
 Installation: Surface
 Product Type: Wall Surface
 Mounting Location: Ceiling
 Light Distribution: Adjustable

PHYSICAL

Shape: Round
 Diameter (mm): 310
 Diameter (in): 12 ³/₁₆
 Height (mm): 310
 Depth (mm): 70
 Height (in): 12 ³/₁₆
 Depth (in): 2 ³/₄
 Extension (mm): 360
 Extension (in): 14 ³/₁₆

Fixture Finish: [GLF_WHI](#) / [GLF_RUS](#) / [CLF_BLK](#) / [WHI_ALU](#) / [WHI_COP](#) / [WHI_WHI](#) / [WHI_BRA](#) / [WHI_RUS](#) / [WHI_BLK](#)

Fixture Material: Aluminum

ELECTRICAL

Lamp Type: LED
 Total Output Wattage (W): 25.2
 Dimming: Non-Dimmable / 0-10V Dimming
 Driver Included: Yes
 Driver Location: Integrated
 Driver Type: Constant Current - 120-277Vac
 Driver Class: Class 2
 Input Voltage (V): 120 - 277
 Constant Current (MA): 700
 Upon Request: 0-10Vdc Dimming

LED

Color Temperature (°K): 2700 / 3000
 Nominal Lumen (lm): 3897
 CRI: >90 CRI
 Lamp Life (hrs): 50000

OPTICAL

RATINGS AND CERTIFICATIONS

Certified By: Certified for North American Standards
 IP rating: IP20

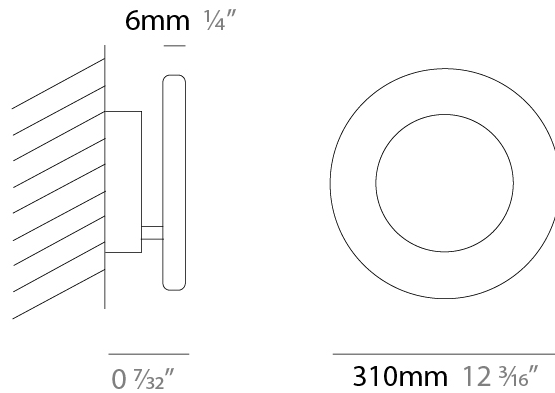

D42065-

PROJECT	_____
TYPE	_____
SPECIFIER	_____
QUANTITY	_____
DATE	_____

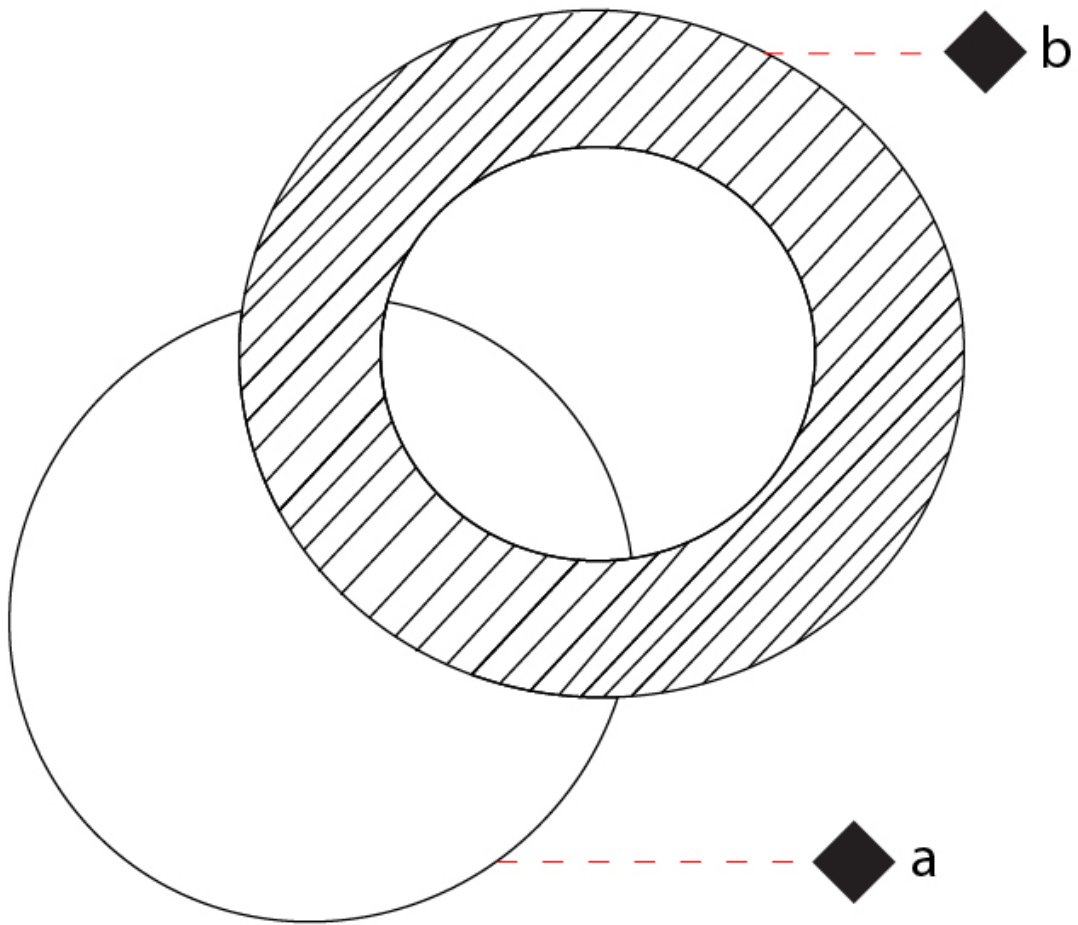

D

PROJECT	_____
TYPE	_____
SPECIFIER	_____
QUANTITY	_____
DATE	_____

VERA SURFACE

D42066- _____ - _____

base number Color _____ Finish _____
 Temperature Options

- To build a product code in our configurator select the specify button on the base model # product page
- To build a manual product code on this datasheet choose from the options listed below in blue font and add the suffix to the base model #

GENERAL

Series: Vera
 Partner: Icone
 Division: Design
 Installation: Surface
 Product Type: Wall Surface
 Mounting Location: Ceiling
 Light Distribution: Adjustable

PHYSICAL

Shape: Round
 Diameter (mm): 500
 Diameter (in): 19 11/16
 Height (mm): 500
 Height (in): 19 11/16
 Extension (mm): 140
 Extension (in): 5 1/2
 Fixture Finish: [GLF_WHI](#) / [GLF_RUS](#) / [CLF_BLK](#) / [WHI_ALU](#) / [WHI_COP](#) / [WHI_WHI](#) / [WHI_BRA](#) / [WHI_RUS](#) / [WHI_BLK](#)
 Fixture Material: Aluminum

ELECTRICAL

Lamp Type: LED
 Total Output Wattage (W): 16.8
 Dimming: Non-Dimmable / 0-10V Dimming
 Driver Included: Yes
 Driver Location: Integrated
 Driver Type: Constant Current - Universal
 Driver Class: Class 2
 Input Voltage (V): 120 - 277
 Constant Current (MA): 700

LED

Color Temperature (°K): [2700](#) / [3000](#)
 Nominal Lumen (lm): 2598
 CRI: >90 CRI
 Lamp Life (hrs): 50000

OPTICAL

RATINGS AND CERTIFICATIONS

Certified By: Certified for North American Standards
 IP rating: IP20

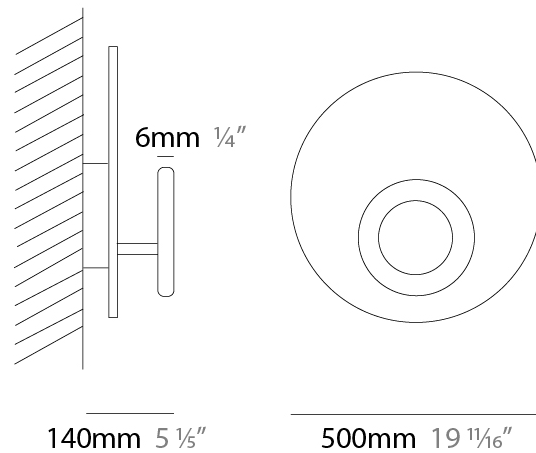

D42066-

PROJECT	_____
TYPE	_____
SPECIFIER	_____
QUANTITY	_____
DATE	_____

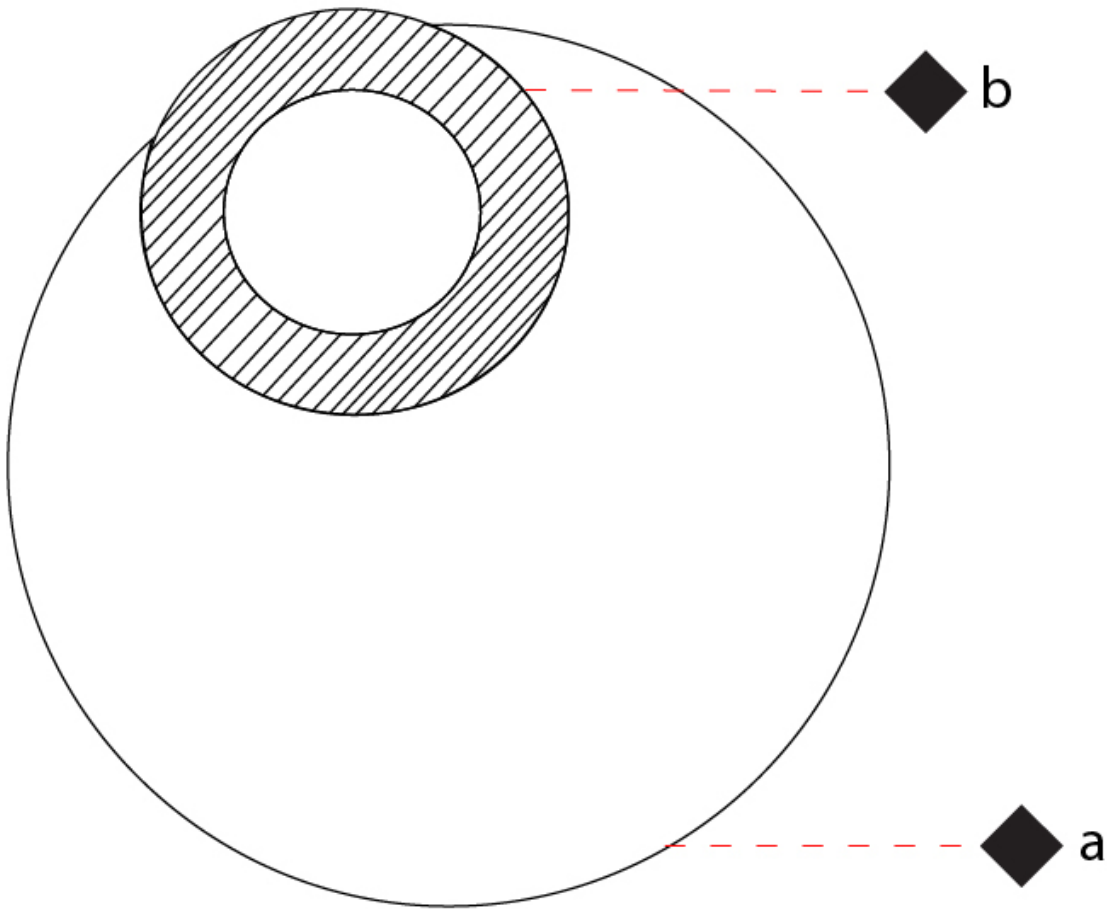

D

VERA SURFACE

D42067- _____ - _____
 base number Color Finish
 Temperature Options

- To build a product code in our configurator select the specify button on the base model # product page
- To build a manual product code on this datasheet choose from the options listed below in blue font and add the suffix to the base model #

GENERAL

Series: Vera
 Partner: Icone
 Division: Design
 Installation: Surface
 Product Type: Wall Surface
 Mounting Location: Ceiling
 Light Distribution: Adjustable

PHYSICAL

Shape: Round
 Diameter (mm): 660
 Diameter (in): 23 ⁵/₈
 Extension (mm): 170
 Extension (in): 6 ¹¹/₁₆
 Fixture Finish: [GLF_WHI](#) / [GLF_RUS](#) / [CLF_BLK](#) / [WHI_ALU](#) / [WHI_COP](#) / [WHI_WHI](#) / [WHI_BRA](#) / [WHI_RUS](#) / [WHI_BLK](#)
 Fixture Material: Aluminum

ELECTRICAL

Lamp Type: LED
 Total Output Wattage (W): 25.2
 Dimming: Non-Dimmable
 Driver Included: Yes
 Driver Location: Integrated
 Driver Type: Constant Current - 120-277Vac
 Driver Class: Class 2
 Input Voltage (V): 120 - 277
 Constant Current (mA): 700
 Upon Request: 0-10Vdc Dimming

LED

Color Temperature (°K): [2700](#) / [3000](#)
 Nominal Lumen (lm): 3897
 CRI: >90 CRI
 Lamp Life (hrs): 50000

OPTICAL

RATINGS AND CERTIFICATIONS

Certified By: Certified for North American Standards
 IP rating: IP20

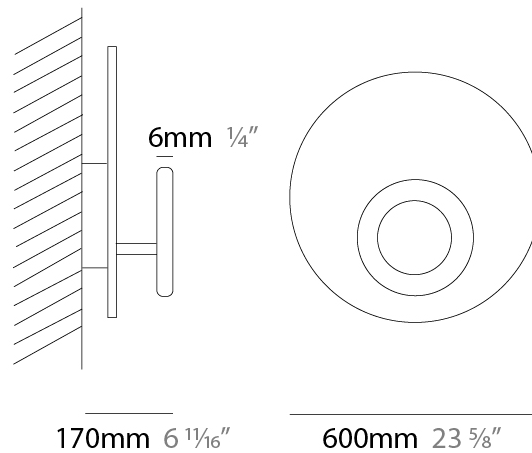

D42067-

PROJECT	_____
TYPE	_____
SPECIFIER	_____
QUANTITY	_____
DATE	_____

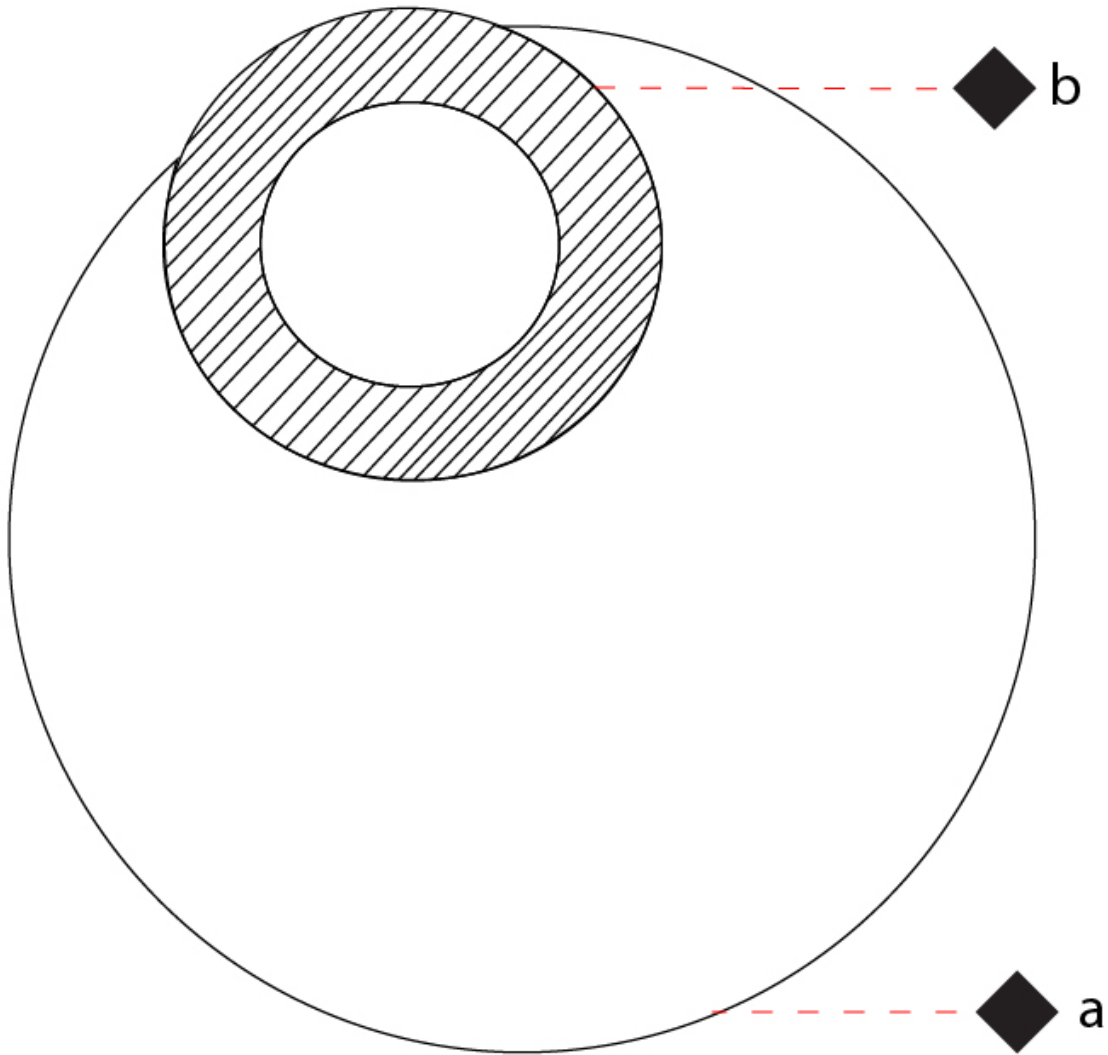

D

PROJECT
TYPE
SPECIFIER
QUANTITY
DATE

VERA PORTABLE

D44008- -

base number Color Finish
 Temperature Options

- To build a product code in our configurator select the specify button on the base model # product page
- To build a manual product code on this datasheet choose from the options listed below in blue font and add the suffix to the base model #

GENERAL

Series: Vera
 Partner: Icone
 Division: Design
 Installation: Portable
 Product Type: Floor
 Mounting Location: Floor
 Light Distribution: Adjustable

PHYSICAL

Shape: Round
 Diameter (mm): 310
 Diameter (in): 12 ³/₁₆
 Height (mm): 1900
 Height (in): 74 ¹³/₁₆
 Fixture Finish: [ALU / BLK / WHI](#)
 Fixture Material: Aluminum
 Upon Request: Bolt Down

ELECTRICAL

Lamp Type: LED
 Total Output Wattage (W): 25.2
 Dimming: Electronic Low Voltage Dimming
 Driver Location: Inline Transformer Plug
 Input Voltage (V): 120
 Constant Current (MA): 700

LED

Color Temperature (°K): [2700 / 3000](#)
 Nominal Lumen (lm): 3897
 CRI: >90 CRI
 Lamp Life (hrs): 50000

OPTICAL

RATINGS AND CERTIFICATIONS

Certified By: Certified for North American Standards
 IP rating: IP20

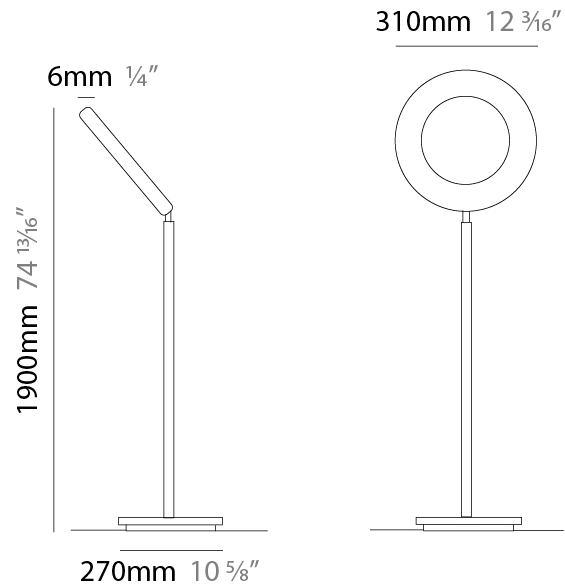

D44008-

PROJECT
TYPE
SPECIFIER
QUANTITY
DATE

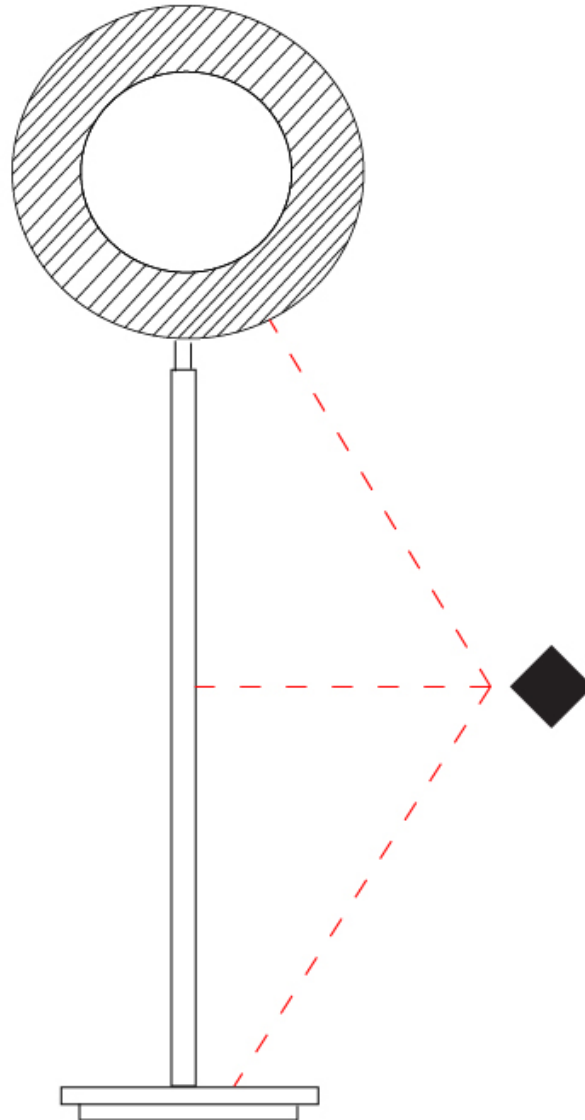

D

PROJECT	_____
TYPE	_____
SPECIFIER	_____
QUANTITY	_____
DATE	_____

Fixture Finish

Aluminum - ALU

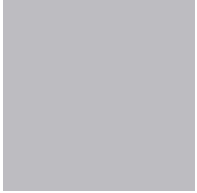

Black - BLK

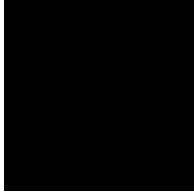

White - WHI



Gold Leaf/White - GLF_WHI



Gold Leaf/Rust - GLF_RUS

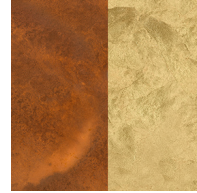

Copper Leaf/Black - CLF_BLK

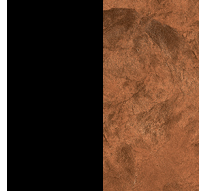

White/Brushed Aluminium - WHI_ALU



White/Bronzed Copper - WHI_COP



White/White - WHI_WHI



White/Brass - WHI_BRA



White/Rust - WHI_RUS







































































White/Black - WHI_BLK













Digital: Not all screens are calibrated the same, and therefore, colors will appear differently between screens.

Physical: When texture is involved, there will be variations in color, character and tone within a product series and between product families.











LEGEND

	floor-mounted		pivotal		special LED (upon request) RGB, RGBW, tunable, gold+, meat+, art+, fashion+
	wall and ceiling: recessed and surface mounted		rotating		warm dim / natural dimming LED
	ceiling-mounted and wall-mounted		illuminate tilted		rechargeable battery powered
	wall-mounted		color of suspension cable		fixture with natural vivid LED (upon request)
	omni-directional light distribution		length of suspension cable		color rendering index
	direct light distribution		reflector degree selection		color temperature
	direct/indirect light distribution		super spot		lumen (luminous flux)
	indirect light distribution		lens		efficacy (lumens per watt)
	asymmetric light distribution		lens pack		Unified Glare Rating (UGR) range from 5-40
	aura light distribution		shine ring		marine grade (AISI 316 stainless steel)
	round wall or ceiling cut-out		integrated shine ring with diffuser		walk on
	square wall or ceiling cut-out		free individual colors 01-29		drive on
	the supplied jig specifies the cutout dimensions		individual colors: 00 (free of charge), 01-25 (extra charge)		Dark Sky Compliance
	minimum distance (meters) lamp - object		luminaire part to be colored (F1)		Americans with Disabilities Act (less than 4" off the wall located between 27"-84" from floor)
	recessed depth		luminaire part to be colored (F2)		lamp protected against explosion
	ceiling thickness in mm		luminaire part to be colored (F3)		blown glass using traditional methods by master glass blower
	ceiling thickness selection		luminaire part to be colored (F4)		acoustic material
	dimmable DP (phase), DV (0-10V), DD (dali), DS (step-dim)		luminaire part to be colored (F5)		protection class I, protection insulation
	included or excluded LED driver/transformer/control gear		color of 3-circuit adaptor		protection class II, protection insulation
	separately switchable		indirect diffuser		ETL Certified to UL and CSA Standards
	sensor		direct diffuser		UL Certified to UL and CSA Standards
	remote control		ball-proof (upon request)		CSA Certified to UL and CSA Standards
	available upon request		accessory		Certified for North American Standards

IP RATING

	protected against ingress of solid bodies greater than 12.5mm (finger)
	protected against ingress of solid bodies greater than 2.5mm protected against sprays of water up to 60 degrees from the vertical (rain)
	protected against ingress of solid bodies greater than 1mm (wire) no protection against the ingress of moisture
	protected against ingress of solid bodies greater than 1mm (wire) protected against sprays of water up to 60 degrees from the vertical (rain)
	protected against ingress of solid bodies greater than 1mm (wire) protected against water splashed from all directions
	protected against limited ingress of dust (wet rooms/covered outdoor areas) protected against water splashed from all directions
	protected against ingress of dust protected against jets of water
	protected against ingress of dust protected against powerful jets of water or heavy seas
	protected against ingress of dust protected against immersion of water between 15cm - 1m for 30 minutes
	protected against ingress of dust protected against immersion of water under pressure for long periods

IK RATING

	protected against 0.14 joules impact (equivalent to 0.25kg mass dropped from 56mm above the surface)
	protected against 0.2 joules impact (equivalent to 0.25kg mass dropped from 80mm above the surface)
	protected against 0.35 joules impact (equivalent to 0.25kg mass dropped from 140mm above the surface)
	protected against 0.5 joules impact (equivalent to 0.25kg mass dropped from 200mm above the surface)
	protected against 0.7 joules impact (equivalent to 0.25kg mass dropped from 280mm above the surface)
	protected against 1 joules impact (equivalent to 0.25kg mass dropped from 400mm above the surface)
	protected against 2 joules impact (equivalent to 0.5kg mass dropped from 400mm above the surface)
	protected against 5 joules impact (equivalent to 1.7kg mass dropped from 300mm above the surface)
	protected against 10 joules impact (equivalent to 5.0kg mass dropped from 200mm above the surface)
	protected against 20 joules impact (equivalent to 5.0kg mass dropped from 400mm above the surface)