

LED60 SURFACE

D72014-

base number
Color Finish
Temperature Options

1. To build a product code in our configurator select the specify button on the base model # product page
2. To build a manual product code on this datasheet choose from the options listed below in blue font and add the suffix to the base model #

GENERAL

Series: Woodlin
Subseries: LED60
Brand: Tunto
Division: Design
Mounting Type: Surface
Mounting Location: Wall / Ceiling
Subcategory: Profile

PHYSICAL

Shape: Rectangle
Length (mm): 400
Length (in): 15 3/4
Width (mm): 60
Width (in): 2 3/8
Height (mm): 60
Height (in): 2 3/8
Light Distribution: Direct
Diffuser: Opal
Fixture Finish: [WAL / ASH / OAK / BLK / WHI](#)
Fixture Material: Wood

ELECTRICAL

Lamp Type: LED
Input Wattage (W): 16
Total Output Wattage (W): 12.6
Dimming: Tri-Mode (Non-Dimming and Phase Dimming (120Vac only) and 0-10V Dimming)
Driver Included: Yes
Driver Location: Remote
Driver Type: Constant Current - Universal
Driver Class: Class 2
Housing: ENCP1
Input Voltage (V): 120 - 277
Constant Current (MA): 700

LED

[Color Temperature \(°K\): 2700 / 3000 / 4000](#)
Max. Delivered Lumen (lm): 1080
CRI: >93 CRI
Lamp Life (hrs): 50000

OPTICAL

RATINGS AND CERTIFICATIONS

Certified By: Certified for North American Standards
IP rating: IP20

PROJECT	_____
TYPE	_____
SPECIFIER	_____
QUANTITY	_____
DATE	_____



400mm 15 3/4"

60mm 2 3/8"



Direct



LED60 SURFACE

D72014-

PROJECT

TYPE

SPECIFIER

QUANTITY

DATE



LED60 SURFACE

D72015-

base number
Color Finish
Temperature Options

- To build a product code in our configurator select the specify button on the base model # product page
- To build a manual product code on this datasheet choose from the options listed below in blue font and add the suffix to the base model #

GENERAL

Series: Woodlin
Subseries: LED60
Brand: Tunto
Division: Design
Mounting Type: Surface
Mounting Location: Wall / Ceiling
Subcategory: Profile

PHYSICAL

Shape: Rectangle
Length (mm): 700
Length (in): 27 ⁵/₁₆
Width (mm): 60
Width (in): 2 ³/₈
Height (mm): 60
Height (in): 2 ³/₈
Light Distribution: Direct
Diffuser: Opal
Fixture Finish: WAL / ASH / OAK / BLK / WHI
Fixture Material: Wood

ELECTRICAL

Lamp Type: LED
Input Wattage (W): 30
Total Output Wattage (W): 25.3
Dimming: Tri-Mode (Non-Dimming and Phase Dimming (120Vac only) and 0-10V Dimming)
Driver Included: Yes
Driver Location: Remote
Driver Type: Constant Current - Universal
Driver Class: Class 2
Housing: ENCP1
Input Voltage (V): 120 - 277
Constant Current (MA): 700

LED

Color Temperature (°K): 2700 / 3000 / 4000
Max. Delivered Lumen (lm): 2180
CRI: >93 CRI
Lamp Life (hrs): 50000

OPTICAL

RATINGS AND CERTIFICATIONS

Certified By: Certified for North American Standards
IP rating: IP20

PROJECT	_____
TYPE	_____
SPECIFIER	_____
QUANTITY	_____
DATE	_____



700mm 27 ⁵/₁₆"

60mm 2 ³/₈"



Direct



LED60 SURFACE

D72015-

PROJECT

TYPE

SPECIFIER

QUANTITY

DATE



LED60 SURFACE

D72016-

base number
Color Finish
Temperature Options

- To build a product code in our configurator select the specify button on the base model # product page
- To build a manual product code on this datasheet choose from the options listed below in blue font and add the suffix to the base model #

GENERAL

Series: Woodlin
Subseries: LED60
Brand: Tunto
Division: Design
Mounting Type: Surface
Mounting Location: Wall / Ceiling
Subcategory: Profile

PHYSICAL

Shape: Rectangle
Length (mm): 400
Length (in): 15 ³/₄
Width (mm): 60
Width (in): 2 ³/₈
Height (mm): 60
Height (in): 2 ³/₈
Light Distribution: Indirect
Diffuser: Opal
Fixture Finish: WAL / ASH / OAK / BLK / WHI
Fixture Material: Wood

ELECTRICAL

Lamp Type: LED
Input Wattage (W): 16
Total Output Wattage (W): 12.6
Dimming: Tri-Mode (Non-Dimming and Phase Dimming (120Vac only) and 0-10V Dimming)
Driver Included: Yes
Driver Location: Remote
Driver Type: Constant Current - Universal
Driver Class: Class 2
Housing: ENCP3
Input Voltage (V): 120 - 277
Constant Current (MA): 700

LED

Color Temperature (°K): 2700 / 3000 / 4000
Max. Delivered Lumen (lm): 1080
CRI: >93 CRI
Lamp Life (hrs): 50000

OPTICAL

RATINGS AND CERTIFICATIONS

Certified By: Certified for North American Standards
IP rating: IP20

PROJECT	_____
TYPE	_____
SPECIFIER	_____
QUANTITY	_____
DATE	_____

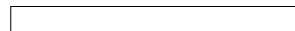

400mm 15 ³/₄"

60mm 2 ³/₈"



Direct



LED60 SURFACE

D72016-

PROJECT

TYPE

SPECIFIER

QUANTITY

DATE

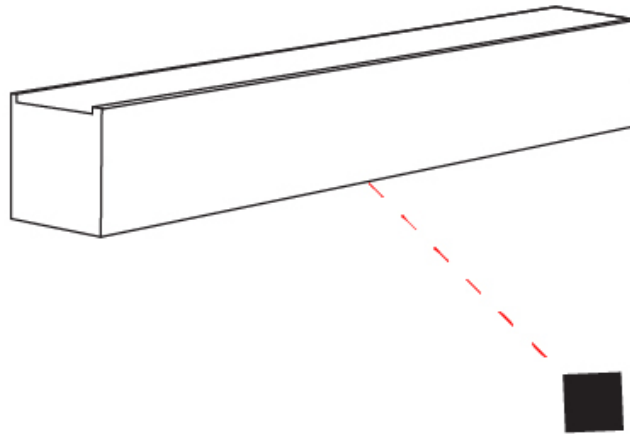

LED60 SURFACE

D72017-

base number Color Finish
 Temperature Options

1. To build a product code in our configurator select the specify button on the base model # product page
2. To build a manual product code on this datasheet choose from the options listed below in blue font and add the suffix to the base model #

GENERAL

Series: Woodlin
Subseries: LED60
Brand: Tunto
Division: Design
Mounting Type: Surface
Mounting Location: Wall / Ceiling
Subcategory: Profile

PHYSICAL

Shape: Rectangle
Length (mm): 700
Length (in): 27 ⁵/₁₆
Width (mm): 60
Width (in): 2 ³/₈
Height (mm): 60
Height (in): 2 ³/₈
Light Distribution: Indirect
Diffuser: Opal
Fixture Finish: WAL / ASH / OAK / BLK / WHI
Fixture Material: Wood

ELECTRICAL

Lamp Type: LED
Input Wattage (W): 28
Total Output Wattage (W): 24
Dimming: Tri-Mode (Non-Dimming and Phase Dimming (120Vac only) and 0-10V Dimming)
Driver Included: Yes
Driver Location: Remote
Driver Type: Constant Current - Universal
Driver Class: Class 2
Housing: ENCP1
Input Voltage (V): 120 - 277
Constant Current (MA): 700

LED

Color Temperature (°K): 2700 / 3000 / 4000
Max. Delivered Lumen (lm): 2180
CRI: >93 CRI
Lamp Life (hrs): 50000

OPTICAL

RATINGS AND CERTIFICATIONS

Certified By: Certified for North American Standards
IP rating: IP20

PROJECT	_____
TYPE	_____
SPECIFIER	_____
QUANTITY	_____
DATE	_____



700mm 27 ⁵/₁₆"

60mm 2 ³/₈"



Indirect



LED60 SURFACE

D72017-

PROJECT

TYPE

SPECIFIER

QUANTITY

DATE

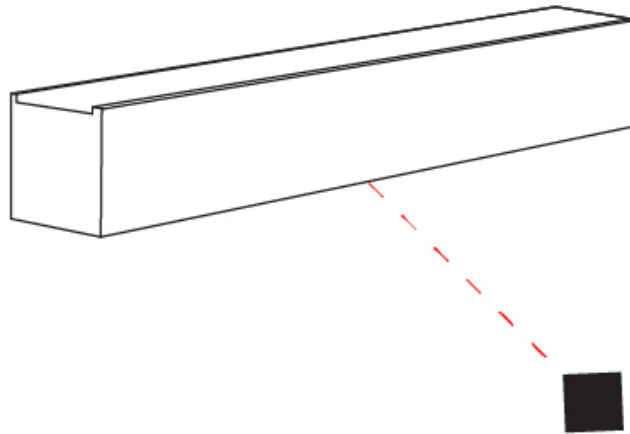

PROJECT

TYPE

SPECIFIER

QUANTITY

DATE

Fixture Finish

Walnut Natural - WAL



Ash White Oil Waxed - ASH



Oak Natural - OAK



Black - BLK



White - WHI

Digital: Not all screens are calibrated the same, and therefore, colors will appear differently between screens.

Physical: When texture is involved, there will be variations in color, character and tone within a product series and between product families.











Wood is a living, organic material. Hence, the patterns and hues can vary, and can change as the material ages. We are not responsible for any natural material transformation and development.













LEGEND

	floor-mounted		pivotal		special LED (upon request) RGB, RGBW, tunable, gold+, meat+, art+, fashion+
	wall and ceiling: recessed and surface mounted		rotating		warm dim / natural dimming LED
	ceiling-mounted and wall-mounted		illuminate tilted		rechargeable battery powered
	wall-mounted		color of suspension cable		fixture with natural vivid LED (upon request)
	omni-directional light distribution		length of suspension cable		color rendering index
	direct light distribution		reflector degree selection		color temperature
	direct/indirect light distribution		super spot		lumen (luminous flux)
	indirect light distribution		lens		efficacy (lumens per watt)
	asymmetric light distribution		lens pack		Unified Glare Rating (UGR) range from 5-40
	aura light distribution		shine ring		marine grade (AISI 316 stainless steel)
	round wall or ceiling cut-out		integrated shine ring with diffuser		walk on
	square wall or ceiling cut-out		free individual colors 01-29		drive on
	the supplied jig specifies the cutout dimensions		individual colors: 00 (free of charge), 01-25 (extra charge)		Dark Sky Compliance
	minimum distance (meters) lamp - object		luminaire part to be colored (F1)		Americans with Disabilities Act (less than 4" off the wall located between 27"-84" from floor)
	recessed depth		luminaire part to be colored (F2)		lamp protected against explosion
	ceiling thickness in mm		luminaire part to be colored (F3)		blown glass using traditional methods by master glass blower
	ceiling thickness selection		luminaire part to be colored (F4)		acoustic material
	dimmable DP (phase), DV (0-10V), DD (dali), DS (step-dim)		luminaire part to be colored (F5)		protection class I, protection insulation
	included or excluded LED driver/transformer/control gear		color of 3-circuit adaptor		protection class II, protection insulation
	separately switchable		indirect diffuser		ETL Certified to UL and CSA Standards
	sensor		direct diffuser		UL Certified to UL and CSA Standards
	remote control		ball-proof (upon request)		CSA Certified to UL and CSA Standards
	available upon request		accessory		Certified for North American Standards

IP RATING

	protected against ingress of solid bodies greater than 12.5mm (finger)
	protected against ingress of solid bodies greater than 2.5mm protected against sprays of water up to 60 degrees from the vertical (rain)
	protected against ingress of solid bodies greater than 1mm (wire) no protection against the ingress of moisture
	protected against ingress of solid bodies greater than 1mm (wire) protected against sprays of water up to 60 degrees from the vertical (rain)
	protected against ingress of solid bodies greater than 1mm (wire) protected against water splashed from all directions
	protected against limited ingress of dust (wet rooms/covered outdoor areas) protected against water splashed from all directions
	protected against ingress of dust protected against jets of water
	protected against ingress of dust protected against powerful jets of water or heavy seas
	protected against ingress of dust protected against immersion of water between 15cm - 1m for 30 minutes
	protected against ingress of dust protected against immersion of water under pressure for long periods

IK RATING

	protected against 0.14 joules impact (equivalent to 0.25kg mass dropped from 56mm above the surface)
	protected against 0.2 joules impact (equivalent to 0.25kg mass dropped from 80mm above the surface)
	protected against 0.35 joules impact (equivalent to 0.25kg mass dropped from 140mm above the surface)
	protected against 0.5 joules impact (equivalent to 0.25kg mass dropped from 200mm above the surface)
	protected against 0.7 joules impact (equivalent to 0.25kg mass dropped from 280mm above the surface)
	protected against 1 joules impact (equivalent to 0.25kg mass dropped from 400mm above the surface)
	protected against 2 joules impact (equivalent to 0.5kg mass dropped from 400mm above the surface)
	protected against 5 joules impact (equivalent to 1.7kg mass dropped from 300mm above the surface)
	protected against 10 joules impact (equivalent to 5.0kg mass dropped from 200mm above the surface)
	protected against 20 joules impact (equivalent to 5.0kg mass dropped from 400mm above the surface)