

## LED40 SUSPENSION

### D71003-

base number            Color            Finish             
 Temperature Options

- To build a product code in our configurator select the specify button on the base model # product page
- To build a manual product code on this datasheet choose from the options listed below in blue font and add the suffix to the base model #

#### GENERAL

Series: Woodlin  
 Subseries: LED40  
 Brand: Tunto  
 Division: Design  
 Mounting Type: Suspension  
 Mounting Location: Ceiling  
 Subcategory: Profile

#### PHYSICAL

Shape: Rectangle  
 Length (mm): 700  
 Length (in): 27 <sup>9</sup>/<sub>16</sub>  
 Width (mm): 400  
 Width (in): 15 <sup>3</sup>/<sub>4</sub>  
 Height (mm): 40  
 Height (in): 1 <sup>9</sup>/<sub>16</sub>  
 Max. Overall Height (mm): 2040  
 Max. Overall Height (in): 80 <sup>5</sup>/<sub>16</sub>  
 Light Distribution: Direct  
 Diffuser: Opal  
 Fixture Finish: [WAL / ASH / OAK / BLK / WHI](#)  
 Fixture Material: Wood

#### ELECTRICAL

Lamp Type: LED  
 Input Wattage (W): 16  
 Total Output Wattage (W): 12.7  
 Dimming: Tri-Mode (Non-Dimming and Phase Dimming (120Vac only) and 0-10V Dimming)  
 Driver Included: Yes  
 Driver Location: Integrated  
 Driver Type: Constant Current - Universal  
 Driver Class: Class 2  
 Input Voltage (V): 120 - 277  
 Constant Current (MA): 700

#### LED

Color Temperature (°K): [2700 / 3000 / 4000](#)  
 Max. Delivered Lumen (lm): 960  
 CRI: >93 CRI  
 Lamp Life (hrs): 50000

#### OPTICAL

#### RATINGS AND CERTIFICATIONS

Certified By: Certified for North American Standards  
 IP rating: IP20

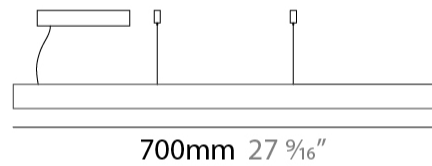

40mm 1 <sup>9</sup>/<sub>16</sub>"



Direct



## LED40 SUSPENSION

D71003-

PROJECT

TYPE

SPECIFIER

QUANTITY

DATE



|           |
|-----------|
| PROJECT   |
| TYPE      |
| SPECIFIER |
| QUANTITY  |
| DATE      |

## LED40 SUSPENSION

### D71004-

base number                          
 Color            Finish  
 Temperature    Options

- To build a product code in our configurator select the specify button on the base model # product page
- To build a manual product code on this datasheet choose from the options listed below in blue font and add the suffix to the base model #

#### GENERAL

Series: Woodlin  
 Subseries: LED40  
 Brand: Tunto  
 Division: Design  
 Mounting Type: Suspension  
 Mounting Location: Ceiling  
 Subcategory: Profile

#### PHYSICAL

Shape: Rectangle  
 Length (mm): 700  
 Length (in): 27 <sup>9</sup>/<sub>16</sub>  
 Width (mm): 400  
 Width (in): 15 <sup>3</sup>/<sub>4</sub>  
 Height (mm): 40  
 Height (in): 1 <sup>9</sup>/<sub>16</sub>  
 Max. Overall Height (mm): 2040  
 Max. Overall Height (in): 80 <sup>5</sup>/<sub>16</sub>  
 Light Distribution: Direct  
 Diffuser: Opal  
 Fixture Finish: [WAL / ASH / OAK / BLK / WHI](#)  
 Fixture Material: Wood

#### ELECTRICAL

Lamp Type: LED  
 Input Wattage (W): 23  
 Total Output Wattage (W): 19  
 Dimming: Tri-Mode (Non-Dimming and Phase Dimming (120Vac only) and 0-10V Dimming)  
 Driver Included: Yes  
 Driver Location: Integrated  
 Driver Type: Constant Current - Universal  
 Driver Class: Class 2  
 Input Voltage (V): 120 - 277  
 Constant Current (MA): 700

#### LED

Color Temperature (°K): 3000  
 Max. Delivered Lumen (lm): 1300  
 CRI: >93 CRI  
 Lamp Life (hrs): 50000

#### OPTICAL

#### RATINGS AND CERTIFICATIONS

Certified By: Certified for North American Standards  
 IP rating: IP20



40mm 1 <sup>9</sup>/<sub>16</sub>"



Direct



## LED40 SUSPENSION

D71004-

PROJECT \_\_\_\_\_

TYPE \_\_\_\_\_

SPECIFIER \_\_\_\_\_

QUANTITY \_\_\_\_\_

DATE \_\_\_\_\_



D

|           |
|-----------|
| PROJECT   |
| TYPE      |
| SPECIFIER |
| QUANTITY  |
| DATE      |

## LED40 SUSPENSION

### D71005-

base number                                      
 Color            Finish  
 Temperature    Options

- To build a product code in our configurator select the specify button on the base model # product page
- To build a manual product code on this datasheet choose from the options listed below in blue font and add the suffix to the base model #

#### GENERAL

Series: Woodlin  
 Subseries: LED40  
 Brand: Tunto  
 Division: Design  
 Mounting Type: Suspension  
 Mounting Location: Ceiling  
 Subcategory: Profile

#### PHYSICAL

Shape: Rectangle  
 Length (mm): 1300  
 Length (in): 51 <sup>3</sup>/<sub>16</sub>"  
 Width (mm): 400  
 Width (in): 15 <sup>3</sup>/<sub>4</sub>"  
 Height (mm): 40  
 Height (in): 1 <sup>9</sup>/<sub>16</sub>"  
 Max. Overall Height (mm): 2040  
 Max. Overall Height (in): 80 <sup>5</sup>/<sub>16</sub>"  
 Light Distribution: Direct  
 Diffuser: Opal  
 Fixture Finish: [WAL / ASH / OAK / BLK / WHI](#)  
 Fixture Material: Wood

#### ELECTRICAL

Lamp Type: LED  
 Input Wattage (W): 30  
 Total Output Wattage (W): 25.4  
 Dimming: Tri-Mode (Non-Dimming and Phase Dimming (120Vac only) and 0-10V Dimming)  
 Driver Included: Yes  
 Driver Location: Integrated  
 Driver Type: Constant Current - Universal  
 Driver Class: Class 2  
 Input Voltage (V): 120 - 277  
 Constant Current (MA): 700

#### LED

Color Temperature (°K): 3000  
 Max. Delivered Lumen (lm): 1550  
 CRI: >93 CRI  
 Lamp Life (hrs): 50000

#### OPTICAL

#### RATINGS AND CERTIFICATIONS

Certified By: Certified for North American Standards  
 IP rating: IP20

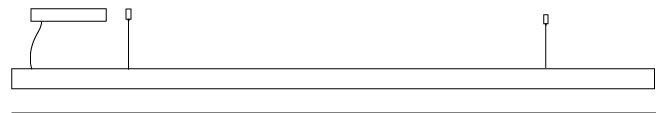

1300mm 51 <sup>3</sup>/<sub>16</sub>"

40mm 1 <sup>9</sup>/<sub>16</sub>"



Direct



## LED40 SUSPENSION

D71005-

PROJECT

TYPE

SPECIFIER

QUANTITY

DATE



D

|           |
|-----------|
| PROJECT   |
| TYPE      |
| SPECIFIER |
| QUANTITY  |
| DATE      |

## LED40 SUSPENSION

### D71006-

base number                                      
 Color                      Finish  
 Temperature            Options

- To build a product code in our configurator select the specify button on the base model # product page
- To build a manual product code on this datasheet choose from the options listed below in blue font and add the suffix to the base model #

#### GENERAL

Series: Woodlin  
 Subseries: LED40  
 Brand: Tunto  
 Division: Design  
 Mounting Type: Suspension  
 Mounting Location: Ceiling  
 Subcategory: Profile

#### PHYSICAL

Shape: Rectangle  
 Length (mm): 1600  
 Length (in): 63  
 Width (mm): 400  
 Width (in): 15 <sup>3</sup>/<sub>4</sub>  
 Height (mm): 40  
 Height (in): 1 <sup>9</sup>/<sub>16</sub>  
 Max. Overall Height (mm): 2040  
 Max. Overall Height (in): 80 <sup>7</sup>/<sub>16</sub>  
 Light Distribution: Direct  
 Diffuser: Opal  
 Fixture Finish: [WAL](#) / [ASH](#) / [OAK](#) / [BLK](#) / [WHI](#)  
 Fixture Material: Wood

#### ELECTRICAL

Lamp Type: LED  
 Input Wattage (W): 36  
 Total Output Wattage (W): 31.5  
 Dimming: Tri-Mode (Non-Dimming and Phase Dimming (120Vac only) and 0-10V Dimming)  
 Driver Included: Yes  
 Driver Location: Integrated  
 Driver Type: Constant Current - Universal  
 Driver Class: Class 2  
 Input Voltage (V): 120 - 277  
 Constant Current (MA): 700

#### LED

Color Temperature (°K): [3000](#)  
 Max. Delivered Lumen (lm): 2100  
 CRI: >93 CRI  
 Lamp Life (hrs): 50000

#### OPTICAL

#### RATINGS AND CERTIFICATIONS

Certified By: Certified for North American Standards  
 IP rating: IP20



1600mm 63"

40mm 1 <sup>9</sup>/<sub>16</sub>"



Direct



## LED40 SUSPENSION

D71006-

PROJECT \_\_\_\_\_

TYPE \_\_\_\_\_

SPECIFIER \_\_\_\_\_

QUANTITY \_\_\_\_\_

DATE \_\_\_\_\_

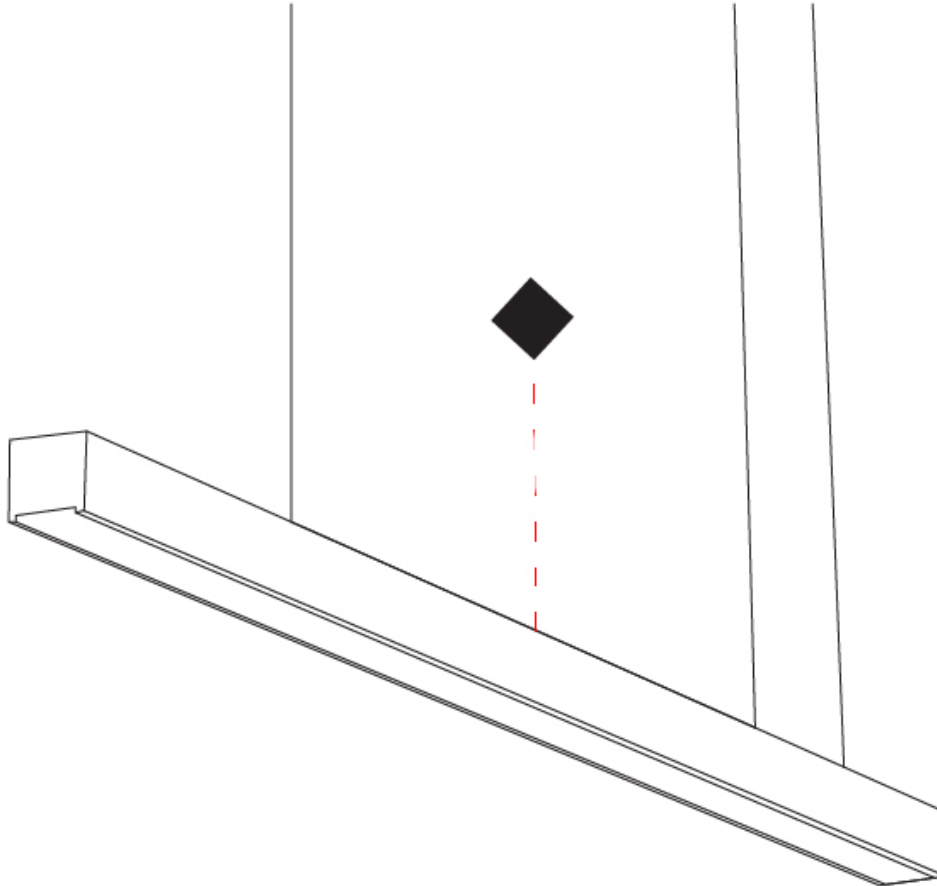

D



|           |
|-----------|
| PROJECT   |
| TYPE      |
| SPECIFIER |
| QUANTITY  |
| DATE      |

## LED28 SUSPENSION

### D71008-

base number                                      
 Color                      Finish  
 Temperature              Options

- To build a product code in our configurator select the specify button on the base model # product page
- To build a manual product code on this datasheet choose from the options listed below in blue font and add the suffix to the base model #

#### GENERAL

Series: Woodlin  
 Subseries: LED28  
 Brand: Tunto  
 Division: Design  
 Mounting Type: Suspension  
 Mounting Location: Ceiling  
 Subcategory: Profile

#### PHYSICAL

Shape: Rectangle  
 Length (mm): 1000  
 Length (in): 39 <sup>3</sup>/<sub>8</sub>"  
 Width (mm): 28  
 Width (in): 1 <sup>1</sup>/<sub>8</sub>"  
 Height (mm): 28  
 Height (in): 1 <sup>1</sup>/<sub>8</sub>"  
 Max. Overall Height (mm): 2028  
 Max. Overall Height (in): 79 <sup>13</sup>/<sub>16</sub>"  
 Light Distribution: Direct  
 Diffuser: Opal  
 Fixture Finish: [WAL / ASH / OAK / BLK / WHI](#)  
 Fixture Material: Wood  
 Cable Details: 2000mm / 78 3/4"

#### ELECTRICAL

Lamp Type: LED  
 Input Wattage (W): 21  
 Total Output Wattage (W): 19  
 Dimming: Tri-Mode (Non-Dimming and Phase Dimming (120Vac only) and 0-10V Dimming)  
 Driver Included: Yes  
 Driver Location: Integrated  
 Driver Type: Constant Current - Universal  
 Driver Class: Class 2  
 Input Voltage (V): 120 - 277  
 Constant Current (MA): 700

#### LED

Color Temperature (°K): [2700 / 3000 / 4000](#)  
 Max. Delivered Lumen (lm): 1200  
 CRI: >93 CRI  
 Lamp Life (hrs): 50000

#### OPTICAL

#### RATINGS AND CERTIFICATIONS

Certified By: Certified for North American Standards  
 IP rating: IP20

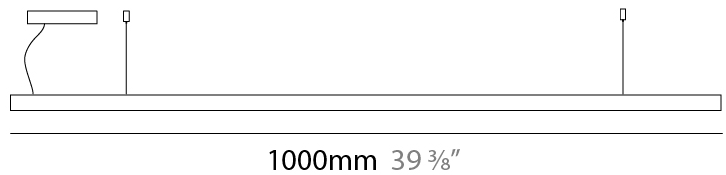

28mm 1 <sup>1</sup>/<sub>8</sub>"



Direct



## LED28 SUSPENSION

D71008-

PROJECT

TYPE

SPECIFIER

QUANTITY

DATE



D

|           |
|-----------|
| PROJECT   |
| TYPE      |
| SPECIFIER |
| QUANTITY  |
| DATE      |

## LED28 SUSPENSION

### D71009-

base number                                      
 Color                      Finish  
 Temperature              Options

- To build a product code in our configurator select the specify button on the base model # product page
- To build a manual product code on this datasheet choose from the options listed below in blue font and add the suffix to the base model #

#### GENERAL

Series: Woodlin  
 Subseries: LED28  
 Brand: Tunto  
 Division: Design  
 Mounting Type: Suspension  
 Mounting Location: Ceiling  
 Subcategory: Profile

#### PHYSICAL

Shape: Rectangle  
 Length (mm): 1200  
 Length (in): 47 1/4  
 Width (mm): 28  
 Width (in): 1 1/8  
 Height (mm): 28  
 Height (in): 1 1/8  
 Max. Overall Height (mm): 2028  
 Max. Overall Height (in): 79 13/16  
 Light Distribution: Direct  
 Diffuser: Opal  
 Fixture Finish: [WAL](#) / [ASH](#) / [OAK](#) / [BLK](#) / [WHI](#)  
 Fixture Material: Wood  
 Cable Details: 2000mm / 78 3/4"

#### ELECTRICAL

Lamp Type: LED  
 Input Wattage (W): 25  
 Total Output Wattage (W): 20.9  
 Dimming: Tri-Mode (Non-Dimming and Phase Dimming (120Vac only) and 0-10V Dimming)  
 Driver Included: Yes  
 Driver Location: Integrated  
 Driver Type: Constant Current - Universal  
 Driver Class: Class 2  
 Input Voltage (V): 120 - 277  
 Constant Current (MA): 700

#### LED

Color Temperature (°K): [2700](#) / [3000](#) / [4000](#)  
 Max. Delivered Lumen (lm): 1300 Standard 3000K  
 CRI: >93 CRI  
 Lamp Life (hrs): 50000

#### OPTICAL

#### RATINGS AND CERTIFICATIONS

Certified By: Certified for North American Standards  
 IP rating: IP20

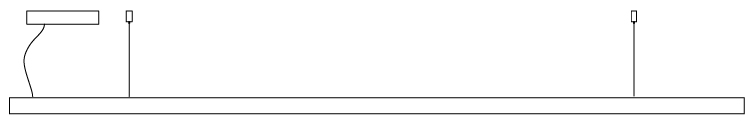

1200mm 47 1/4"

28mm 1 1/8"



Direct



## LED28 SUSPENSION

D71009-

PROJECT \_\_\_\_\_

TYPE \_\_\_\_\_

SPECIFIER \_\_\_\_\_

QUANTITY \_\_\_\_\_

DATE \_\_\_\_\_



## LED60 SUSPENSION

**D71015-** -

base number                              
Color            Temperature    Finish            Options

- To build a product code in our configurator select the specify button on the base model # product page
- To build a manual product code on this datasheet choose from the options listed below in blue font and add the suffix to the base model #

### GENERAL

Series: Woodlin  
Subseries: LED60  
Brand: Tunto  
Division: Design  
Mounting Type: Suspension  
Mounting Location: Ceiling  
Subcategory: Profile

### PHYSICAL

Shape: Rectangle  
Length (mm): 700  
Length (in): 27 <sup>9</sup>/<sub>16</sub>  
Width (mm): 60  
Width (in): 2 <sup>3</sup>/<sub>8</sub>  
Height (mm): 60  
Height (in): 2 <sup>3</sup>/<sub>8</sub>  
Max. Overall Height (mm): 2060  
Max. Overall Height (in): 81 <sup>7</sup>/<sub>8</sub>  
Light Distribution: Direct  
Diffuser: Opal  
Fixture Finish: [WAL / ASH / OAK / BLK / WHI](#)  
Fixture Material: Wood  
Cable Details: 2000mm / 78 3/4"

### ELECTRICAL

Lamp Type: LED  
Input Wattage (W): 29  
Total Output Wattage (W): 25.3  
Dimming: Tri-Mode (Non-Dimming and Phase Dimming (120Vac only) and 0-10V Dimming)  
Driver Included: Yes  
Driver Location: Integrated  
Driver Type: Constant Current - Universal  
Driver Class: Class 2  
Input Voltage (V): 120 - 277  
Constant Current (MA): 700

### LED

Color Temperature (°K): [2700 / 3000 / 4000](#)  
Max. Delivered Lumen (lm): 2180  
CRI: >93 CRI  
Lamp Life (hrs): 50000

### OPTICAL

#### RATINGS AND CERTIFICATIONS

Certified By: Certified for North American Standards  
IP rating: IP20

|           |       |
|-----------|-------|
| PROJECT   | _____ |
| TYPE      | _____ |
| SPECIFIER | _____ |
| QUANTITY  | _____ |
| DATE      | _____ |



## LED60 SUSPENSION

D71015-

PROJECT

TYPE

SPECIFIER

QUANTITY

DATE



D

|           |
|-----------|
| PROJECT   |
| TYPE      |
| SPECIFIER |
| QUANTITY  |
| DATE      |

## LED60 SUSPENSION

### D71016-

base number    Color    Finish  
 Temperature    Options

- To build a product code in our configurator select the specify button on the base model # product page
- To build a manual product code on this datasheet choose from the options listed below in blue font and add the suffix to the base model #

#### GENERAL

Series: Woodlin  
 Subseries: LED60  
 Brand: Tunto  
 Division: Design  
 Mounting Type: Suspension  
 Mounting Location: Ceiling  
 Subcategory: Profile

#### PHYSICAL

Shape: Rectangle  
 Length (mm): 1000  
 Length (in): 39 <sup>3</sup>/<sub>8</sub>"  
 Width (mm): 60  
 Width (in): 2 <sup>3</sup>/<sub>8</sub>"  
 Height (mm): 60  
 Height (in): 2 <sup>3</sup>/<sub>8</sub>"  
 Max. Overall Height (mm): 2060  
 Max. Overall Height (in): 81 <sup>1</sup>/<sub>8</sub>"  
 Light Distribution: Direct  
 Diffuser: Opal  
 Fixture Finish: [WAL / ASH / OAK / BLK / WHI](#)  
 Fixture Material: Wood  
 Cable Details: 2000mm / 78 3/4"

#### ELECTRICAL

Lamp Type: LED  
 Input Wattage (W): 43  
 Total Output Wattage (W): 38  
 Dimming: Tri-Mode (Non-Dimming and Phase Dimming (120Vac only) and 0-10V Dimming)  
 Driver Included: Yes  
 Driver Location: Integrated  
 Driver Type: Constant Current - Universal  
 Driver Class: Class 2  
 Input Voltage (V): 120 - 277  
 Constant Current (MA): 700

#### LED

Color Temperature (°K): [2700 / 3000 / 4000](#)  
 Max. Delivered Lumen (lm): 3240  
 CRI: >93 CRI  
 Lamp Life (hrs): 50000

#### OPTICAL

#### RATINGS AND CERTIFICATIONS

Certified By: Certified for North American Standards  
 IP rating: IP20

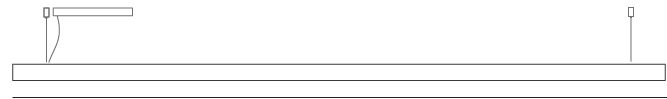

1000mm 39 <sup>3</sup>/<sub>8</sub>"

60mm 2 <sup>3</sup>/<sub>8</sub>"



Direct



## LED60 SUSPENSION

D71016-

PROJECT \_\_\_\_\_

TYPE \_\_\_\_\_

SPECIFIER \_\_\_\_\_

QUANTITY \_\_\_\_\_

DATE \_\_\_\_\_





|           |
|-----------|
| PROJECT   |
| TYPE      |
| SPECIFIER |
| QUANTITY  |
| DATE      |

## LED60 SUSPENSION

### D71017-

base number                                      
 Color                      Finish  
 Temperature            Options

- To build a product code in our configurator select the specify button on the base model # product page
- To build a manual product code on this datasheet choose from the options listed below in blue font and add the suffix to the base model #

#### GENERAL

Series: Woodlin  
 Subseries: LED60  
 Brand: Tunto  
 Division: Design  
 Mounting Type: Suspension  
 Mounting Location: Ceiling  
 Subcategory: Profile

#### PHYSICAL

Shape: Rectangle  
 Length (mm): 1300  
 Length (in): 51 <sup>3</sup>/<sub>16</sub>  
 Width (mm): 60  
 Width (in): 2 <sup>3</sup>/<sub>8</sub>  
 Height (mm): 60  
 Height (in): 2 <sup>3</sup>/<sub>8</sub>  
 Max. Overall Height (mm): 2060  
 Max. Overall Height (in): 81 <sup>1</sup>/<sub>8</sub>  
 Light Distribution: Direct  
 Diffuser: Opal  
 Fixture Finish: [WAL / ASH / OAK / BLK / WHI](#)  
 Fixture Material: Wood  
 Cable Details: 2000mm / 78 3/4"

#### ELECTRICAL

Lamp Type: LED  
 Input Wattage (W): 55  
 Total Output Wattage (W): 50.8  
 Dimming: Tri-Mode (Non-Dimming and Phase Dimming (120Vac only) and 0-10V Dimming)  
 Driver Included: Yes  
 Driver Location: Integrated  
 Driver Type: Constant Current - Universal  
 Driver Class: Class 2  
 Input Voltage (V): 120 - 277  
 Constant Current (MA): 700

#### LED

Color Temperature (°K): [2700 / 3000 / 4000](#)  
 Max. Delivered Lumen (lm): 4380  
 CRI: >93 CRI  
 Lamp Life (hrs): 50000

#### OPTICAL

#### RATINGS AND CERTIFICATIONS

Certified By: Certified for North American Standards  
 IP rating: IP20

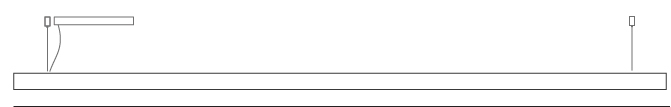

1300mm 51 <sup>3</sup>/<sub>16</sub>"

60mm 2 <sup>3</sup>/<sub>8</sub>"



Direct



## LED60 SUSPENSION

D71017-

PROJECT

TYPE

SPECIFIER

QUANTITY

DATE



D

|           |
|-----------|
| PROJECT   |
| TYPE      |
| SPECIFIER |
| QUANTITY  |
| DATE      |

## LED60 SUSPENSION

### D71018-

base number                          
 Color            Finish  
 Temperature    Options

- To build a product code in our configurator select the specify button on the base model # product page
- To build a manual product code on this datasheet choose from the options listed below in blue font and add the suffix to the base model #

#### GENERAL

Series: Woodlin  
 Subseries: LED60  
 Brand: Tunto  
 Division: Design  
 Mounting Type: Suspension  
 Mounting Location: Ceiling  
 Subcategory: Profile

#### PHYSICAL

Shape: Rectangle  
 Length (mm): 1600  
 Length (in): 63  
 Width (mm): 60  
 Width (in): 2 <sup>3</sup>/<sub>8</sub>  
 Height (mm): 60  
 Height (in): 2 <sup>3</sup>/<sub>8</sub>  
 Max. Overall Height (mm): 2060  
 Max. Overall Height (in): 81 <sup>1</sup>/<sub>8</sub>  
 Light Distribution: Direct  
 Diffuser: Opal  
 Fixture Finish: [WAL](#) / [ASH](#) / [OAK](#) / [BLK](#) / [WHI](#)  
 Fixture Material: Wood  
 Cable Details: 2000mm / 78 3/4"

#### ELECTRICAL

Lamp Type: LED  
 Input Wattage (W): 70  
 Total Output Wattage (W): 63  
 Dimming: Tri-Mode (Non-Dimming and Phase Dimming (120Vac only) and 0-10V Dimming)  
 Driver Included: Yes  
 Driver Location: Integrated  
 Driver Type: Constant Current - Universal  
 Driver Class: Class 2  
 Input Voltage (V): 120 - 277  
 Constant Current (MA): 700

#### LED

Color Temperature (°K): [2700](#) / [3000](#) / [4000](#)  
 Max. Delivered Lumen (lm): 5450  
 CRI: >93 CRI  
 Lamp Life (hrs): 50000

#### OPTICAL

#### RATINGS AND CERTIFICATIONS

Certified By: Certified for North American Standards  
 IP rating: IP20



1600mm 63"

60mm 2 <sup>3</sup>/<sub>8</sub>"



Direct



## LED60 SUSPENSION

D71018-

PROJECT

TYPE

SPECIFIER

QUANTITY

DATE



|           |
|-----------|
| PROJECT   |
| TYPE      |
| SPECIFIER |
| QUANTITY  |
| DATE      |

## LED60 SUSPENSION

**D71019-** -

base number                          
 Color            Temperature    Finish            Options

- To build a product code in our configurator select the specify button on the base model # product page
- To build a manual product code on this datasheet choose from the options listed below in blue font and add the suffix to the base model #

### GENERAL

Series: Woodlin  
 Subseries: LED60  
 Brand: Tunto  
 Division: Design  
 Mounting Type: Suspension  
 Mounting Location: Ceiling  
 Subcategory: Profile

### PHYSICAL

Shape: Rectangle  
 Length (mm): 2000  
 Length (in): 78 ¾  
 Width (mm): 60  
 Width (in): 2 ⅜  
 Height (mm): 60  
 Height (in): 2 ⅜  
 Max. Overall Height (mm): 2060  
 Max. Overall Height (in): 81 ⅞  
 Light Distribution: Direct  
 Diffuser: Opal  
 Fixture Finish: [WAL / ASH / OAK / BLK / WHI](#)  
 Fixture Material: Wood  
 Cable Details: 2000mm / 78 ¾"

### ELECTRICAL

Lamp Type: LED  
 Input Wattage (W): 90  
 Total Output Wattage (W): 75.9  
 Dimming: Tri-Mode (Non-Dimming and Phase Dimming (120Vac only) and 0-10V Dimming)  
 Driver Included: Yes  
 Driver Location: Integrated  
 Driver Type: Constant Current - Universal  
 Driver Class: Class 2  
 Input Voltage (V): 120 - 277  
 Constant Current (MA): 700

### LED

Color Temperature (°K): [2700 / 3000 / 4000](#)  
 Max. Delivered Lumen (lm): 6550  
 CRI: >93 CRI  
 Lamp Life (hrs): 50000

### OPTICAL

#### RATINGS AND CERTIFICATIONS

Certified By: Certified for North American Standards  
 IP rating: IP20

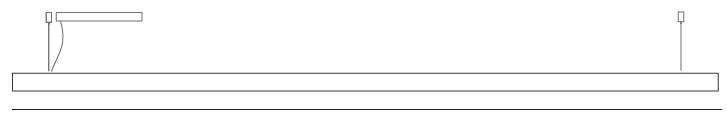

2000mm 78 ¾"

60mm 2 ⅜"



Direct



## LED60 SUSPENSION

D71019-

PROJECT

TYPE

SPECIFIER

QUANTITY

DATE



|           |
|-----------|
| PROJECT   |
| TYPE      |
| SPECIFIER |
| QUANTITY  |
| DATE      |

## LED60 SUSPENSION

**D71020-** -

base number    Color    Finish  
 Temperature    Options

- To build a product code in our configurator select the specify button on the base model # product page
- To build a manual product code on this datasheet choose from the options listed below in blue font and add the suffix to the base model #

### GENERAL

Series: Woodlin  
 Subseries: LED60  
 Brand: Tunto  
 Division: Design  
 Mounting Type: Suspension  
 Mounting Location: Ceiling  
 Subcategory: Profile

### PHYSICAL

Shape: Rectangle  
 Length (mm): 2400  
 Length (in): 94 1/2  
 Width (mm): 60  
 Width (in): 2 3/8  
 Height (mm): 60  
 Height (in): 2 3/8  
 Max. Overall Height (mm): 2060  
 Max. Overall Height (in): 81 1/8  
 Light Distribution: Direct  
 Diffuser: Opal  
 Fixture Finish: [WAL / ASH / OAK / BLK / WHI](#)  
 Fixture Material: Wood  
 Cable Details: 2000mm / 78 3/4"

### ELECTRICAL

Lamp Type: LED  
 Input Wattage (W): 110  
 Total Output Wattage (W): 88.8  
 Dimming: Tri-Mode (Non-Dimming and Phase Dimming (120Vac only) and 0-10V Dimming)  
 Driver Included: Yes  
 Driver Location: Integrated  
 Driver Type: Constant Current - Universal  
 Driver Class: Class 2  
 Input Voltage (V): 120 - 277  
 Constant Current (MA): 700

### LED

Color Temperature (°K): [2700 / 3000 / 4000](#)  
 Max. Delivered Lumen (lm): 8750  
 CRI: >93 CRI  
 Lamp Life (hrs): 50000

### OPTICAL

#### RATINGS AND CERTIFICATIONS

Certified By: Certified for North American Standards  
 IP rating: IP20



2400mm 94 1/2"

60mm 2 3/8"



Direct



## LED60 SUSPENSION

D71020-

PROJECT

TYPE

SPECIFIER

QUANTITY

DATE





PROJECT \_\_\_\_\_  
 TYPE \_\_\_\_\_  
 SPECIFIER \_\_\_\_\_  
 QUANTITY \_\_\_\_\_  
 DATE \_\_\_\_\_

## LED120 SUSPENSION

### D71023-

base number                          
 Color            Finish  
 Temperature    Options

- To build a product code in our configurator select the specify button on the base model # product page
- To build a manual product code on this datasheet choose from the options listed below in blue font and add the suffix to the base model #

#### GENERAL

Series: Woodlin  
 Subseries: LED120  
 Brand: Tunto  
 Division: Design  
 Mounting Type: Suspension  
 Mounting Location: Ceiling  
 Subcategory: Profile

#### PHYSICAL

Shape: Rectangle  
 Length (mm): 700  
 Length (in): 27 <sup>9</sup>/<sub>16</sub>  
 Width (mm): 40  
 Width (in): 1 <sup>9</sup>/<sub>16</sub>  
 Height (mm): 120  
 Height (in): 4 <sup>3</sup>/<sub>4</sub>  
 Max. Overall Height (mm): 2120  
 Max. Overall Height (in): 83 <sup>7</sup>/<sub>16</sub>  
 Light Distribution: Direct / Indirect  
 Diffuser: Opal  
 Fixture Finish: [WAL / ASH / OAK / BLK / WHI](#)  
 Fixture Material: Wood  
 Cable Details: 2000mm / 78 3/4"

#### ELECTRICAL

Lamp Type: LED  
 Input Wattage (W): 32  
 Total Output Wattage (W): 25.3  
 Dimming: Tri-Mode (Non-Dimming and Phase Dimming (120Vac only) and 0-10V Dimming)  
 Driver Included: Yes  
 Driver Location: Integrated  
 Driver Type: Constant Current - Universal  
 Driver Class: Class 2  
 Input Voltage (V): 120 - 277  
 Constant Current (MA): 700

#### LED

Color Temperature (°K): [2700 / 3000 / 4000](#)  
 Max. Delivered Lumen (lm): 1500  
 CRI: >93 CRI  
 Lamp Life (hrs): 50000

#### OPTICAL

#### RATINGS AND CERTIFICATIONS

Certified By: Certified for North American Standards  
 IP rating: IP20

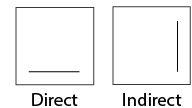

## LED120 SUSPENSION

D71023-

PROJECT

TYPE

SPECIFIER

QUANTITY

DATE



D

PROJECT \_\_\_\_\_  
 TYPE \_\_\_\_\_  
 SPECIFIER \_\_\_\_\_  
 QUANTITY \_\_\_\_\_  
 DATE \_\_\_\_\_

## LED120 SUSPENSION

### D71024-

base number                          
 Color            Finish  
 Temperature    Options

- To build a product code in our configurator select the specify button on the base model # product page
- To build a manual product code on this datasheet choose from the options listed below in blue font and add the suffix to the base model #

#### GENERAL

Series: Woodlin  
 Subseries: LED120  
 Brand: Tunto  
 Division: Design  
 Mounting Type: Suspension  
 Mounting Location: Ceiling  
 Subcategory: Profile

#### PHYSICAL

Shape: Rectangle  
 Length (mm): 1000  
 Length (in): 39 <sup>3</sup>/<sub>8</sub>  
 Width (mm): 40  
 Width (in): 1 <sup>9</sup>/<sub>16</sub>  
 Height (mm): 120  
 Height (in): 4 <sup>3</sup>/<sub>4</sub>  
 Max. Overall Height (mm): 2120  
 Max. Overall Height (in): 83 <sup>7</sup>/<sub>16</sub>  
 Light Distribution: Direct / Indirect  
 Diffuser: Opal  
 Fixture Finish: [WAL](#) / [ASH](#) / [OAK](#) / [BLK](#) / [WHI](#)  
 Fixture Material: Wood  
 Cable Details: 2000mm / 78 3/4"

#### ELECTRICAL

Lamp Type: LED  
 Input Wattage (W): 46  
 Total Output Wattage (W): 38  
 Dimming: Tri-Mode (Non-Dimming and Phase Dimming (120Vac only) and 0-10V Dimming)  
 Driver Included: Yes  
 Driver Location: Integrated  
 Driver Type: Constant Current - Universal  
 Driver Class: Class 2  
 Input Voltage (V): 120 - 277  
 Constant Current (MA): 700

#### LED

Color Temperature (°K): [2700](#) / [3000](#) / [4000](#)  
 Max. Delivered Lumen (lm): 2200  
 CRI: >93 CRI  
 Lamp Life (hrs): 50000

#### OPTICAL

#### RATINGS AND CERTIFICATIONS

Certified By: Certified for North American Standards  
 IP rating: IP20

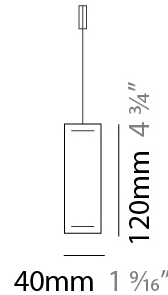

## LED120 SUSPENSION

D71024-

PROJECT \_\_\_\_\_

TYPE \_\_\_\_\_

SPECIFIER \_\_\_\_\_

QUANTITY \_\_\_\_\_

DATE \_\_\_\_\_



D

PROJECT \_\_\_\_\_  
 TYPE \_\_\_\_\_  
 SPECIFIER \_\_\_\_\_  
 QUANTITY \_\_\_\_\_  
 DATE \_\_\_\_\_

## LED120 SUSPENSION

### D71025-

base number \_\_\_\_\_  
 Color \_\_\_\_\_  
 Temperature \_\_\_\_\_  
 Finish \_\_\_\_\_  
 Options \_\_\_\_\_

- To build a product code in our configurator select the specify button on the base model # product page
- To build a manual product code on this datasheet choose from the options listed below in blue font and add the suffix to the base model #

#### GENERAL

Series: Woodlin  
 Subseries: LED120  
 Brand: Tunto  
 Division: Design  
 Mounting Type: Suspension  
 Mounting Location: Ceiling  
 Subcategory: Profile

#### PHYSICAL

Shape: Rectangle  
 Length (mm): 1300  
 Length (in): 51 <sup>3</sup>/<sub>16</sub>  
 Width (mm): 40  
 Width (in): 1 <sup>9</sup>/<sub>16</sub>  
 Height (mm): 120  
 Height (in): 4 <sup>3</sup>/<sub>4</sub>  
 Max. Overall Height (mm): 2120  
 Max. Overall Height (in): 83 <sup>7</sup>/<sub>16</sub>  
 Light Distribution: Direct / Indirect  
 Diffuser: Opal  
 Fixture Finish: WAL / ASH / OAK / BLK / WHI  
 Fixture Material: Wood  
 Cable Details: 2000mm / 78 3/4"

#### ELECTRICAL

Lamp Type: LED  
 Input Wattage (W): 60  
 Total Output Wattage (W): 50.1  
 Dimming: Tri-Mode (Non-Dimming and Phase Dimming (120Vac only) and 0-10V Dimming)  
 Driver Included: Yes  
 Driver Location: Integrated  
 Driver Type: Constant Current - Universal  
 Driver Class: Class 2  
 Input Voltage (V): 120 - 277  
 Constant Current (MA): 700

#### LED

Color Temperature (°K): 2700 / 3000 / 4000  
 Max. Delivered Lumen (lm): 3260  
 CRI: >93 CRI  
 Lamp Life (hrs): 50000

#### OPTICAL

#### RATINGS AND CERTIFICATIONS

Certified By: Certified for North American Standards  
 IP rating: IP20

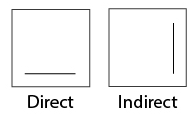

## LED120 SUSPENSION

D71025-

PROJECT

TYPE

SPECIFIER

QUANTITY

DATE



D

PROJECT \_\_\_\_\_  
 TYPE \_\_\_\_\_  
 SPECIFIER \_\_\_\_\_  
 QUANTITY \_\_\_\_\_  
 DATE \_\_\_\_\_

## LED120 SUSPENSION

### D71026-

base number      Color      Finish  
 Temperature      Options

- To build a product code in our configurator select the specify button on the base model # product page
- To build a manual product code on this datasheet choose from the options listed below in blue font and add the suffix to the base model #

#### GENERAL

Series: Woodlin  
 Subseries: LED120  
 Brand: Tunto  
 Division: Design  
 Mounting Type: Suspension  
 Mounting Location: Ceiling  
 Subcategory: Profile

#### PHYSICAL

Shape: Rectangle  
 Length (mm): 1600  
 Length (in): 63  
 Width (mm): 40  
 Width (in): 1 9/16  
 Height (mm): 120  
 Height (in): 4 3/4  
 Max. Overall Height (mm): 2120  
 Max. Overall Height (in): 83 7/16  
 Light Distribution: Direct / Indirect  
 Diffuser: Opal  
 Fixture Finish: WAL / ASH / OAK / BLK / WHI  
 Fixture Material: Wood  
 Cable Details: 2000mm / 78 3/4"

#### ELECTRICAL

Lamp Type: LED  
 Input Wattage (W): 74  
 Total Output Wattage (W): 63  
 Dimming: Tri-Mode (Non-Dimming and Phase Dimming (120Vac only) and 0-10V Dimming)  
 Driver Included: Yes  
 Driver Location: Integrated  
 Driver Type: Constant Current - Universal  
 Driver Class: Class 2  
 Input Voltage (V): 120 - 277  
 Constant Current (MA): 700

#### LED

Color Temperature (°K): 2700 / 3000 / 4000  
 Max. Delivered Lumen (lm): 3600  
 CRI: >93 CRI  
 Lamp Life (hrs): 50000

#### OPTICAL

#### RATINGS AND CERTIFICATIONS

Certified By: Certified for North American Standards  
 IP rating: IP20

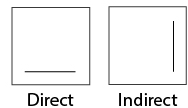
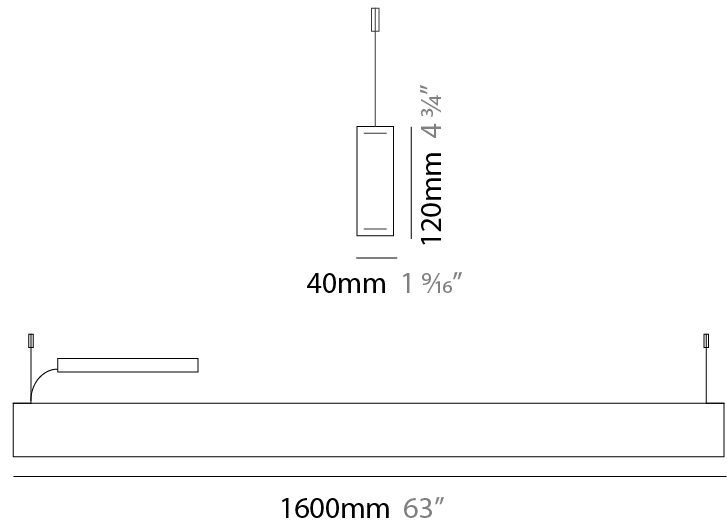

## LED120 SUSPENSION

D71026-

PROJECT \_\_\_\_\_

TYPE \_\_\_\_\_

SPECIFIER \_\_\_\_\_

QUANTITY \_\_\_\_\_

DATE \_\_\_\_\_



D



|           |
|-----------|
| PROJECT   |
| TYPE      |
| SPECIFIER |
| QUANTITY  |
| DATE      |

## LED40 SURFACE

### D72005-

base number                                      
 Color            Temperature    Finish            Options

- To build a product code in our configurator select the specify button on the base model # product page
- To build a manual product code on this datasheet choose from the options listed below in blue font and add the suffix to the base model #

#### GENERAL

Series: Woodlin  
 Subseries: LED40  
 Brand: Tunto  
 Division: Design  
 Mounting Type: Surface  
 Mounting Location: Wall / Ceiling  
 Subcategory: Profile

#### PHYSICAL

Shape: Rectangle  
 Length (mm): 400  
 Length (in): 15 3/4  
 Width (mm): 40  
 Width (in): 1 9/16  
 Height (mm): 40  
 Height (in): 1 9/16  
 Light Distribution: Direct  
 Diffuser: Opal  
 Fixture Finish: WAL / ASH / OAK / BLK / WHI  
 Fixture Material: Wood

#### ELECTRICAL

Lamp Type: LED  
 Input Wattage (W): 9  
 Total Output Wattage (W): 6.3  
 Dimming: Tri-Mode (Non-Dimming and Phase Dimming (120Vac only) and 0-10V Dimming)  
 Driver Included: Yes  
 Driver Location: Remote  
 Driver Type: Constant Current - Universal  
 Driver Class: Class 2  
 Housing: ENCP3  
 Input Voltage (V): 120 - 277  
 Constant Current (MA): 700

#### LED

Color Temperature (°K): 2700 / 3000 / 4000  
 Max. Delivered Lumen (lm): 480  
 CRI: >93 CRI  
 Lamp Life (hrs): 50000

#### OPTICAL

#### RATINGS AND CERTIFICATIONS

Certified By: Certified for North American Standards  
 IP rating: IP20

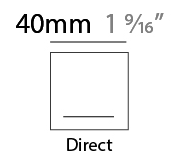

## LED40 SURFACE

D72005-

PROJECT

TYPE

SPECIFIER

QUANTITY

DATE



D

|           |
|-----------|
| PROJECT   |
| TYPE      |
| SPECIFIER |
| QUANTITY  |
| DATE      |

## LED40 SURFACE

### D72006-

base number                                      
 Color            Finish  
 Temperature    Options

- To build a product code in our configurator select the specify button on the base model # product page
- To build a manual product code on this datasheet choose from the options listed below in blue font and add the suffix to the base model #

#### GENERAL

Series: Woodlin  
 Subseries: LED40  
 Brand: Tunto  
 Division: Design  
 Mounting Type: Surface  
 Mounting Location: Wall / Ceiling  
 Subcategory: Profile

#### PHYSICAL

Shape: Rectangle  
 Length (mm): 700  
 Length (in): 27 <sup>9</sup>/<sub>16</sub>  
 Width (mm): 40  
 Width (in): 1 <sup>9</sup>/<sub>16</sub>  
 Height (mm): 40  
 Height (in): 1 <sup>9</sup>/<sub>16</sub>  
 Light Distribution: Direct  
 Diffuser: Opal  
 Fixture Finish: WAL / ASH / OAK / BLK / WHI  
 Fixture Material: Wood

#### ELECTRICAL

Lamp Type: LED  
 Input Wattage (W): 16  
 Total Output Wattage (W): 12.6  
 Dimming: Tri-Mode (Non-Dimming and Phase Dimming (120Vac only) and 0-10V Dimming)  
 Driver Included: Yes  
 Driver Location: Remote  
 Driver Type: Constant Current - Universal  
 Driver Class: Class 2  
 Housing: ENCP3  
 Input Voltage (V): 120 - 277  
 Constant Current (MA): 700

#### LED

Color Temperature (°K): 2700 / 3000 / 4000  
 Max. Delivered Lumen (lm): 960  
 CRI: >93 CRI  
 Lamp Life (hrs): 50000

#### OPTICAL

#### RATINGS AND CERTIFICATIONS

Certified By: Certified for North American Standards  
 IP rating: IP20

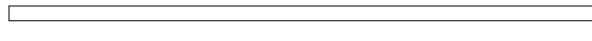

700mm 27 <sup>9</sup>/<sub>16</sub>"

40mm 1 <sup>9</sup>/<sub>16</sub>"



Direct



## LED40 SURFACE

D72006-

PROJECT

TYPE

SPECIFIER

QUANTITY

DATE



D

|           |
|-----------|
| PROJECT   |
| TYPE      |
| SPECIFIER |
| QUANTITY  |
| DATE      |

## LED40 SURFACE

### D72007-

base number                                      
 Color            Temperature    Finish            Options

- To build a product code in our configurator select the specify button on the base model # product page
- To build a manual product code on this datasheet choose from the options listed below in blue font and add the suffix to the base model #

#### GENERAL

Series: Woodlin  
 Subseries: LED40  
 Brand: Tunto  
 Division: Design  
 Mounting Type: Surface  
 Mounting Location: Wall / Ceiling  
 Subcategory: Profile

#### PHYSICAL

Shape: Rectangle  
 Length (mm): 1000  
 Length (in): 39 <sup>3</sup>/<sub>8</sub>  
 Width (mm): 40  
 Width (in): 1 <sup>9</sup>/<sub>16</sub>  
 Height (mm): 40  
 Height (in): 1 <sup>9</sup>/<sub>16</sub>  
 Light Distribution: Direct  
 Diffuser: Opal  
 Fixture Finish: WAL / ASH / OAK / BLK / WHI  
 Fixture Material: Wood

#### ELECTRICAL

Lamp Type: LED  
 Input Wattage (W): 23  
 Total Output Wattage (W): 19  
 Dimming: Tri-Mode (Non-Dimming and Phase Dimming (120Vac only) and 0-10V Dimming)  
 Driver Included: Yes  
 Driver Location: Remote  
 Driver Type: Constant Current - Universal  
 Driver Class: Class 2  
 Housing: ENCP1  
 Input Voltage (V): 120 - 277  
 Constant Current (MA): 700

#### LED

Color Temperature (°K): 2700 / 3000 / 4000  
 Max. Delivered Lumen (lm): 1300  
 CRI: >93 CRI  
 Lamp Life (hrs): 50000

#### OPTICAL

#### RATINGS AND CERTIFICATIONS

Certified By: Certified for North American Standards  
 IP rating: IP20

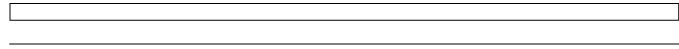

1000mm 39 <sup>3</sup>/<sub>8</sub>"

40mm 1 <sup>9</sup>/<sub>16</sub>"



Direct



## LED40 SURFACE

D72007-

PROJECT

TYPE

SPECIFIER

QUANTITY

DATE



D

|           |
|-----------|
| PROJECT   |
| TYPE      |
| SPECIFIER |
| QUANTITY  |
| DATE      |

## LED40 SURFACE

### D72008-

base number                                      
 Color            Temperature    Finish            Options

- To build a product code in our configurator select the specify button on the base model # product page
- To build a manual product code on this datasheet choose from the options listed below in blue font and add the suffix to the base model #

#### GENERAL

Series: Woodlin  
 Subseries: LED40  
 Brand: Tunto  
 Division: Design  
 Mounting Type: Surface  
 Mounting Location: Wall / Ceiling  
 Subcategory: Profile

#### PHYSICAL

Shape: Rectangle  
 Length (mm): 1300  
 Length (in): 51 <sup>3</sup>/<sub>16</sub>  
 Width (mm): 40  
 Width (in): 1 <sup>9</sup>/<sub>16</sub>  
 Height (mm): 40  
 Height (in): 1 <sup>9</sup>/<sub>16</sub>  
 Light Distribution: Direct  
 Diffuser: Opal  
 Fixture Finish: WAL / ASH / OAK / BLK / WHI  
 Fixture Material: Wood

#### ELECTRICAL

Lamp Type: LED  
 Input Wattage (W): 29  
 Total Output Wattage (W): 25.4  
 Dimming: Tri-Mode (Non-Dimming and Phase Dimming (120Vac only) and 0-10V Dimming)  
 Driver Included: Yes  
 Driver Location: Remote  
 Driver Type: Constant Current - Universal  
 Driver Class: Class 2  
 Housing: ENCP1  
 Input Voltage (V): 120 - 277  
 Constant Current (MA): 700

#### LED

Color Temperature (°K): 2700 / 3000 / 4000  
 Max. Delivered Lumen (lm): 1550  
 CRI: >93 CRI  
 Lamp Life (hrs): 50000

#### OPTICAL

#### RATINGS AND CERTIFICATIONS

Certified By: Certified for North American Standards  
 IP rating: IP20



1300mm 51 <sup>3</sup>/<sub>16</sub>"

40mm 1 <sup>9</sup>/<sub>16</sub>"



Direct



## LED40 SURFACE

D72008-

PROJECT

TYPE

SPECIFIER

QUANTITY

DATE



D



|           |
|-----------|
| PROJECT   |
| TYPE      |
| SPECIFIER |
| QUANTITY  |
| DATE      |

## LED40 SURFACE

### D72009-

base number                                      
 Color            Temperature    Finish            Options

- To build a product code in our configurator select the specify button on the base model # product page
- To build a manual product code on this datasheet choose from the options listed below in blue font and add the suffix to the base model #

#### GENERAL

Series: Woodlin  
 Subseries: LED40  
 Brand: Tunto  
 Division: Design  
 Mounting Type: Surface  
 Mounting Location: Wall / Ceiling  
 Subcategory: Profile

#### PHYSICAL

Shape: Rectangle  
 Length (mm): 1600  
 Length (in): 63  
 Width (mm): 40  
 Width (in): 1 9/16  
 Height (mm): 40  
 Height (in): 1 9/16  
 Light Distribution: Direct  
 Diffuser: Opal  
 Fixture Finish: [WAL / ASH / OAK / BLK / WHI](#)  
 Fixture Material: Wood

#### ELECTRICAL

Lamp Type: LED  
 Input Wattage (W): 35  
 Total Output Wattage (W): 31.5  
 Dimming: Tri-Mode (Non-Dimming and Phase Dimming (120Vac only) and 0-10V Dimming)  
 Driver Included: Yes  
 Driver Location: Remote  
 Driver Type: Constant Current - Universal  
 Driver Class: Class 2  
 Housing: ENCP1  
 Input Voltage (V): 120 - 277  
 Constant Current (MA): 700

#### LED

Color Temperature (°K): [2700 / 3000 / 4000](#)  
 Max. Delivered Lumen (lm): 2100  
 CRI: >93 CRI  
 Lamp Life (hrs): 50000

#### OPTICAL

#### RATINGS AND CERTIFICATIONS

Certified By: Certified for North American Standards  
 IP rating: IP20



1600mm 63"

40mm 1 9/16"



Direct



## LED40 SURFACE

D72009-

PROJECT

TYPE

SPECIFIER

QUANTITY

DATE



D

## LED28 SURFACE

### D72012-

base number                                      
Color                      Finish  
Temperature              Options

- To build a product code in our configurator select the specify button on the base model # product page
- To build a manual product code on this datasheet choose from the options listed below in blue font and add the suffix to the base model #

#### GENERAL

Series: Woodlin  
Subseries: LED28  
Brand: Tunto  
Division: Design  
Mounting Type: Surface  
Mounting Location: Wall / Ceiling  
Subcategory: Profile

#### PHYSICAL

Shape: Rectangle  
Length (mm): 1000  
Length (in): 39 <sup>3</sup>/<sub>8</sub>  
Width (mm): 28  
Width (in): 1 <sup>1</sup>/<sub>8</sub>  
Height (mm): 28  
Height (in): 1 <sup>1</sup>/<sub>8</sub>  
Light Distribution: Direct  
Diffuser: Opal  
Fixture Finish: [WAL / ASH / OAK / BLK / WHI](#)  
Fixture Material: Wood

#### ELECTRICAL

Lamp Type: LED  
Input Wattage (W): 21  
Total Output Wattage (W): 19  
Dimming: Tri-Mode (Non-Dimming and Phase Dimming (120Vac only) and 0-10V Dimming)  
Driver Included: Yes  
Driver Location: Remote  
Driver Type: Constant Current - Universal  
Driver Class: Class 2  
Housing: ENCP1  
Input Voltage (V): 120 - 277  
Constant Current (MA): 700

#### LED

[Color Temperature \(°K\): 2700 / 3000 / 4000](#)  
Max. Delivered Lumen (lm): 1200  
CRI: >93 CRI  
Lamp Life (hrs): 50000

#### OPTICAL

#### RATINGS AND CERTIFICATIONS

Certified By: Certified for North American Standards  
IP rating: IP20

|           |       |
|-----------|-------|
| PROJECT   | _____ |
| TYPE      | _____ |
| SPECIFIER | _____ |
| QUANTITY  | _____ |
| DATE      | _____ |

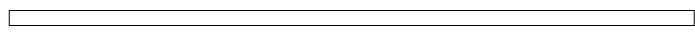

1000mm 39 <sup>3</sup>/<sub>8</sub>"

28mm 1 <sup>1</sup>/<sub>8</sub>"



Direct



## LED28 SURFACE

D72012-

PROJECT

TYPE

SPECIFIER

QUANTITY

DATE



## LED28 SURFACE

### D72013-

base number    Color    Finish  
Temperature    Options

- To build a product code in our configurator select the specify button on the base model # product page
- To build a manual product code on this datasheet choose from the options listed below in blue font and add the suffix to the base model #

#### GENERAL

Series: Woodlin  
Subseries: LED28  
Brand: Tunto  
Division: Design  
Mounting Type: Surface  
Mounting Location: Wall / Ceiling  
Subcategory: Profile

#### PHYSICAL

Shape: Rectangle  
Length (mm): 1200  
Length (in): 47 1/4  
Width (mm): 28  
Width (in): 1 1/8  
Height (mm): 28  
Height (in): 1 1/8  
Light Distribution: Direct  
Diffuser: Opal  
Fixture Finish: WAL / ASH / OAK / BLK / WHI  
Fixture Material: Wood

#### ELECTRICAL

Lamp Type: LED  
Input Wattage (W): 25  
Total Output Wattage (W): 23.5  
Dimming: Tri-Mode (Non-Dimming and Phase Dimming (120Vac only) and 0-10V Dimming)  
Driver Included: Yes  
Driver Location: Remote  
Driver Type: Constant Current - Universal  
Driver Class: Class 2  
Housing: ENCP1  
Input Voltage (V): 120 - 277  
Constant Current (MA): 700

#### LED

Color Temperature (°K): 2700 / 3000 / 4000  
Max. Delivered Lumen (lm): 1400  
CRI: >93 CRI  
Lamp Life (hrs): 50000

#### OPTICAL

#### RATINGS AND CERTIFICATIONS

Certified By: Certified for North American Standards  
IP rating: IP20

|           |       |
|-----------|-------|
| PROJECT   | _____ |
| TYPE      | _____ |
| SPECIFIER | _____ |
| QUANTITY  | _____ |
| DATE      | _____ |



1200mm 47 1/4"

28mm 1 1/8"



Direct



## LED28 SURFACE

D72013-

|           |       |
|-----------|-------|
| PROJECT   | _____ |
| TYPE      | _____ |
| SPECIFIER | _____ |
| QUANTITY  | _____ |
| DATE      | _____ |

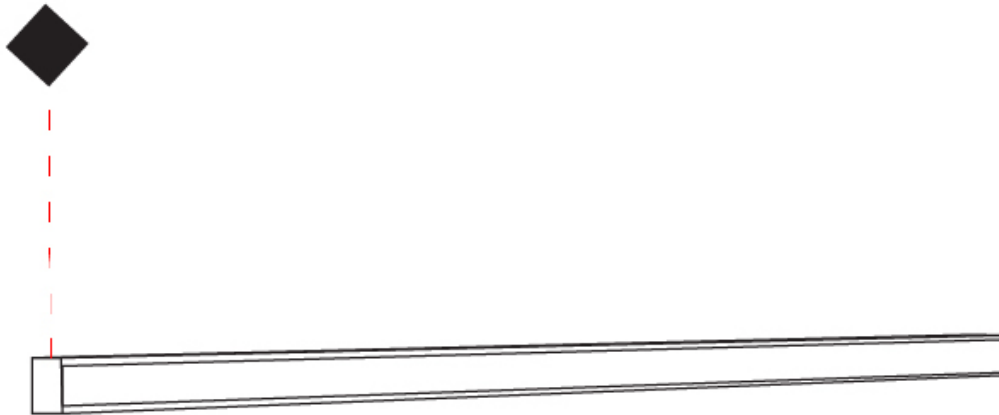

## LED60 SURFACE

### D72014-

base number                          
Color            Finish  
Temperature    Options

1. To build a product code in our configurator select the specify button on the base model # product page
2. To build a manual product code on this datasheet choose from the options listed below in blue font and add the suffix to the base model #

#### GENERAL

Series: Woodlin  
Subseries: LED60  
Brand: Tunto  
Division: Design  
Mounting Type: Surface  
Mounting Location: Wall / Ceiling  
Subcategory: Profile

#### PHYSICAL

Shape: Rectangle  
Length (mm): 400  
Length (in): 15 <sup>3</sup>/<sub>4</sub>  
Width (mm): 60  
Width (in): 2 <sup>3</sup>/<sub>8</sub>  
Height (mm): 60  
Height (in): 2 <sup>3</sup>/<sub>8</sub>  
Light Distribution: Direct  
Diffuser: Opal  
Fixture Finish: [WAL / ASH / OAK / BLK / WHI](#)  
Fixture Material: Wood

#### ELECTRICAL

Lamp Type: LED  
Input Wattage (W): 16  
Total Output Wattage (W): 12.6  
Dimming: Tri-Mode (Non-Dimming and Phase Dimming (120Vac only) and 0-10V Dimming)  
Driver Included: Yes  
Driver Location: Remote  
Driver Type: Constant Current - Universal  
Driver Class: Class 2  
Housing: ENCP1  
Input Voltage (V): 120 - 277  
Constant Current (MA): 700

#### LED

Color Temperature (°K): [2700 / 3000 / 4000](#)  
Max. Delivered Lumen (lm): 1080  
CRI: >93 CRI  
Lamp Life (hrs): 50000

#### OPTICAL

#### RATINGS AND CERTIFICATIONS

Certified By: Certified for North American Standards  
IP rating: IP20

|           |       |
|-----------|-------|
| PROJECT   | _____ |
| TYPE      | _____ |
| SPECIFIER | _____ |
| QUANTITY  | _____ |
| DATE      | _____ |



400mm 15 <sup>3</sup>/<sub>4</sub>"

60mm 2 <sup>3</sup>/<sub>8</sub>"



Direct



## LED60 SURFACE

D72014-

PROJECT

TYPE

SPECIFIER

QUANTITY

DATE





## LED60 SURFACE

### D72015-

base number                                      
 Color                      Finish  
 Temperature              Options

- To build a product code in our configurator select the specify button on the base model # product page
- To build a manual product code on this datasheet choose from the options listed below in blue font and add the suffix to the base model #

#### GENERAL

Series: Woodlin  
 Subseries: LED60  
 Brand: Tunto  
 Division: Design  
 Mounting Type: Surface  
 Mounting Location: Wall / Ceiling  
 Subcategory: Profile

#### PHYSICAL

Shape: Rectangle  
 Length (mm): 700  
 Length (in): 27 <sup>5</sup>/<sub>16</sub>  
 Width (mm): 60  
 Width (in): 2 <sup>3</sup>/<sub>8</sub>  
 Height (mm): 60  
 Height (in): 2 <sup>3</sup>/<sub>8</sub>  
 Light Distribution: Direct  
 Diffuser: Opal  
 Fixture Finish: [WAL / ASH / OAK / BLK / WHI](#)  
 Fixture Material: Wood

#### ELECTRICAL

Lamp Type: LED  
 Input Wattage (W): 30  
 Total Output Wattage (W): 25.3  
 Dimming: Tri-Mode (Non-Dimming and Phase Dimming (120Vac only) and 0-10V Dimming)  
 Driver Included: Yes  
 Driver Location: Remote  
 Driver Type: Constant Current - Universal  
 Driver Class: Class 2  
 Housing: ENCP1  
 Input Voltage (V): 120 - 277  
 Constant Current (MA): 700

#### LED

[Color Temperature \(°K\): 2700 / 3000 / 4000](#)  
 Max. Delivered Lumen (lm): 2180  
 CRI: >93 CRI  
 Lamp Life (hrs): 50000

#### OPTICAL

#### RATINGS AND CERTIFICATIONS

Certified By: Certified for North American Standards  
 IP rating: IP20

|           |
|-----------|
| PROJECT   |
| TYPE      |
| SPECIFIER |
| QUANTITY  |
| DATE      |



700mm 27 <sup>5</sup>/<sub>16</sub>"

60mm 2 <sup>3</sup>/<sub>8</sub>"



Direct



## LED60 SURFACE

D72015-

PROJECT

TYPE

SPECIFIER

QUANTITY

DATE



## LED60 SURFACE

### D72016-

base number                                      
Color                      Finish  
Temperature              Options

- To build a product code in our configurator select the specify button on the base model # product page
- To build a manual product code on this datasheet choose from the options listed below in blue font and add the suffix to the base model #

#### GENERAL

Series: Woodlin  
Subseries: LED60  
Brand: Tunto  
Division: Design  
Mounting Type: Surface  
Mounting Location: Wall / Ceiling  
Subcategory: Profile

#### PHYSICAL

Shape: Rectangle  
Length (mm): 400  
Length (in): 15 <sup>3</sup>/<sub>4</sub>  
Width (mm): 60  
Width (in): 2 <sup>3</sup>/<sub>8</sub>  
Height (mm): 60  
Height (in): 2 <sup>3</sup>/<sub>8</sub>  
Light Distribution: Indirect  
Diffuser: Opal  
Fixture Finish: WAL / ASH / OAK / BLK / WHI  
Fixture Material: Wood

#### ELECTRICAL

Lamp Type: LED  
Input Wattage (W): 16  
Total Output Wattage (W): 12.6  
Dimming: Tri-Mode (Non-Dimming and Phase Dimming (120Vac only) and 0-10V Dimming)  
Driver Included: Yes  
Driver Location: Remote  
Driver Type: Constant Current - Universal  
Driver Class: Class 2  
Housing: ENCP3  
Input Voltage (V): 120 - 277  
Constant Current (MA): 700

#### LED

Color Temperature (°K): 2700 / 3000 / 4000  
Max. Delivered Lumen (lm): 1080  
CRI: >93 CRI  
Lamp Life (hrs): 50000

#### OPTICAL

#### RATINGS AND CERTIFICATIONS

Certified By: Certified for North American Standards  
IP rating: IP20

|           |       |
|-----------|-------|
| PROJECT   | _____ |
| TYPE      | _____ |
| SPECIFIER | _____ |
| QUANTITY  | _____ |
| DATE      | _____ |



400mm 15 <sup>3</sup>/<sub>4</sub>"

60mm 2 <sup>3</sup>/<sub>8</sub>"



Direct



## LED60 SURFACE

D72016-

PROJECT

TYPE

SPECIFIER

QUANTITY

DATE



## LED60 SURFACE

### D72017-

base number    Color    Finish  
                    Temperature    Options

1. To build a product code in our configurator select the specify button on the base model # product page
2. To build a manual product code on this datasheet choose from the options listed below in blue font and add the suffix to the base model #

#### GENERAL

Series: Woodlin  
Subseries: LED60  
Brand: Tunto  
Division: Design  
Mounting Type: Surface  
Mounting Location: Wall / Ceiling  
Subcategory: Profile

#### PHYSICAL

Shape: Rectangle  
Length (mm): 700  
Length (in): 27 <sup>5</sup>/<sub>16</sub>  
Width (mm): 60  
Width (in): 2 <sup>3</sup>/<sub>8</sub>  
Height (mm): 60  
Height (in): 2 <sup>3</sup>/<sub>8</sub>  
Light Distribution: Indirect  
Diffuser: Opal  
Fixture Finish: WAL / ASH / OAK / BLK / WHI  
Fixture Material: Wood

#### ELECTRICAL

Lamp Type: LED  
Input Wattage (W): 28  
Total Output Wattage (W): 24  
Dimming: Tri-Mode (Non-Dimming and Phase Dimming (120Vac only) and 0-10V Dimming)  
Driver Included: Yes  
Driver Location: Remote  
Driver Type: Constant Current - Universal  
Driver Class: Class 2  
Housing: ENCP1  
Input Voltage (V): 120 - 277  
Constant Current (MA): 700

#### LED

Color Temperature (°K): 2700 / 3000 / 4000  
Max. Delivered Lumen (lm): 2180  
CRI: >93 CRI  
Lamp Life (hrs): 50000

#### OPTICAL

#### RATINGS AND CERTIFICATIONS

Certified By: Certified for North American Standards  
IP rating: IP20

|           |       |
|-----------|-------|
| PROJECT   | _____ |
| TYPE      | _____ |
| SPECIFIER | _____ |
| QUANTITY  | _____ |
| DATE      | _____ |

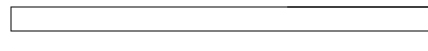

700mm 27 <sup>5</sup>/<sub>16</sub>"

60mm 2 <sup>3</sup>/<sub>8</sub>"



Indirect



## LED60 SURFACE

D72017-

PROJECT

TYPE

SPECIFIER

QUANTITY

DATE



|           |
|-----------|
| PROJECT   |
| TYPE      |
| SPECIFIER |
| QUANTITY  |
| DATE      |

## LED40 SURFACE

### D72018-

base number                                      
 Color                      Finish  
 Temperature              Options

- To build a product code in our configurator select the specify button on the base model # product page
- To build a manual product code on this datasheet choose from the options listed below in blue font and add the suffix to the base model #

#### GENERAL

Series: Woodlin  
 Subseries: LED40  
 Brand: Tunto  
 Division: Design  
 Mounting Type: Surface  
 Mounting Location: Wall / Ceiling  
 Subcategory: Profile

#### PHYSICAL

Shape: Rectangle  
 Length (mm): 400  
 Length (in): 15 ¾  
 Width (mm): 40  
 Width (in): 1 ⅙  
 Height (mm): 40  
 Height (in): 1 ⅙  
 Light Distribution: Indirect  
 Diffuser: Opal  
 Fixture Finish: WAL / ASH / OAK / BLK / WHI  
 Fixture Material: Wood

#### ELECTRICAL

Lamp Type: LED  
 Input Wattage (W): 9  
 Total Output Wattage (W): 6.3  
 Dimming: Tri-Mode (Non-Dimming and Phase Dimming (120Vac only) and 0-10V Dimming)  
 Driver Included: Yes  
 Driver Location: Remote  
 Driver Type: Constant Current - Universal  
 Driver Class: Class 2  
 Housing: ENCP3  
 Input Voltage (V): 120 - 277  
 Constant Current (MA): 700

#### LED

Color Temperature (°K): 2700 / 3000 / 4000  
 Max. Delivered Lumen (lm): 480  
 CRI: >93 CRI  
 Lamp Life (hrs): 50000

#### OPTICAL

#### RATINGS AND CERTIFICATIONS

Certified By: Certified for North American Standards  
 IP rating: IP20

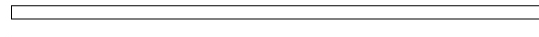

400mm 15 ¾"

40mm 1 ⅙"



Indirect



## LED40 SURFACE

D72018-

|           |       |
|-----------|-------|
| PROJECT   | _____ |
| TYPE      | _____ |
| SPECIFIER | _____ |
| QUANTITY  | _____ |
| DATE      | _____ |





|           |
|-----------|
| PROJECT   |
| TYPE      |
| SPECIFIER |
| QUANTITY  |
| DATE      |

## LED40 SURFACE

### D72019-

base number                                      
 Color            Temperature    Finish            Options

- To build a product code in our configurator select the specify button on the base model # product page
- To build a manual product code on this datasheet choose from the options listed below in blue font and add the suffix to the base model #

#### GENERAL

Series: Woodlin  
 Subseries: LED40  
 Brand: Tunto  
 Division: Design  
 Mounting Type: Surface  
 Mounting Location: Wall / Ceiling  
 Subcategory: Profile

#### PHYSICAL

Shape: Rectangle  
 Length (mm): 700  
 Length (in): 27 <sup>9</sup>/<sub>16</sub>  
 Width (mm): 40  
 Width (in): 1 <sup>9</sup>/<sub>16</sub>  
 Height (mm): 40  
 Height (in): 1 <sup>9</sup>/<sub>16</sub>  
 Light Distribution: Indirect  
 Diffuser: Opal  
 Fixture Finish: WAL / ASH / OAK / BLK / WHI  
 Fixture Material: Wood

#### ELECTRICAL

Lamp Type: LED  
 Input Wattage (W): 16  
 Total Output Wattage (W): 12.6  
 Dimming: Tri-Mode (Non-Dimming and Phase Dimming (120Vac only) and 0-10V Dimming)  
 Driver Included: Yes  
 Driver Location: Remote  
 Driver Type: Constant Current - Universal  
 Driver Class: Class 2  
 Housing: ENCP3  
 Input Voltage (V): 120 - 277  
 Constant Current (MA): 700

#### LED

Color Temperature (°K): 2700 / 3000 / 4000  
 Max. Delivered Lumen (lm): 960  
 CRI: >93 CRI  
 Lamp Life (hrs): 50000

#### OPTICAL

#### RATINGS AND CERTIFICATIONS

Certified By: Certified for North American Standards  
 IP rating: IP20

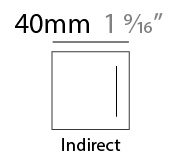

## LED40 SURFACE

D72019-

PROJECT

TYPE

SPECIFIER

QUANTITY

DATE



|           |
|-----------|
| PROJECT   |
| TYPE      |
| SPECIFIER |
| QUANTITY  |
| DATE      |

## LED40 SURFACE

### D72020-

base number                                      
 Color            Finish  
 Temperature    Options

- To build a product code in our configurator select the specify button on the base model # product page
- To build a manual product code on this datasheet choose from the options listed below in blue font and add the suffix to the base model #

#### GENERAL

Series: Woodlin  
 Subseries: LED40  
 Brand: Tunto  
 Division: Design  
 Mounting Type: Surface  
 Mounting Location: Wall / Ceiling  
 Subcategory: Profile

#### PHYSICAL

Shape: Rectangle  
 Length (mm): 1000  
 Length (in): 39 <sup>3</sup>/<sub>8</sub>  
 Width (mm): 40  
 Width (in): 1 <sup>9</sup>/<sub>16</sub>  
 Height (mm): 40  
 Height (in): 1 <sup>9</sup>/<sub>16</sub>  
 Light Distribution: Indirect  
 Diffuser: Opal  
 Fixture Finish: WAL / ASH / OAK / BLK / WHI  
 Fixture Material: Wood

#### ELECTRICAL

Lamp Type: LED  
 Input Wattage (W): 23  
 Total Output Wattage (W): 19  
 Dimming: Tri-Mode (Non-Dimming and Phase Dimming (120Vac only) and 0-10V Dimming)  
 Driver Included: Yes  
 Driver Location: Remote  
 Driver Type: Constant Current - Universal  
 Driver Class: Class 2  
 Housing: ENCP1  
 Input Voltage (V): 120 - 277  
 Constant Current (MA): 700

#### LED

Color Temperature (°K): 2700 / 3000 / 4000  
 Max. Delivered Lumen (lm): 1300  
 CRI: >93 CRI  
 Lamp Life (hrs): 50000

#### OPTICAL

#### RATINGS AND CERTIFICATIONS

Certified By: Certified for North American Standards  
 IP rating: IP20



1000mm 39 <sup>3</sup>/<sub>8</sub>"

40mm 1 <sup>9</sup>/<sub>16</sub>"



Indirect



## LED40 SURFACE

D72020-

|           |       |
|-----------|-------|
| PROJECT   | _____ |
| TYPE      | _____ |
| SPECIFIER | _____ |
| QUANTITY  | _____ |
| DATE      | _____ |



|           |
|-----------|
| PROJECT   |
| TYPE      |
| SPECIFIER |
| QUANTITY  |
| DATE      |

## LED40 SURFACE

### D72021-

base number                                      
 Color            Finish  
 Temperature    Options

- To build a product code in our configurator select the specify button on the base model # product page
- To build a manual product code on this datasheet choose from the options listed below in blue font and add the suffix to the base model #

#### GENERAL

Series: Woodlin  
 Subseries: LED40  
 Brand: Tunto  
 Division: Design  
 Mounting Type: Surface  
 Mounting Location: Wall / Ceiling  
 Subcategory: Profile

#### PHYSICAL

Shape: Rectangle  
 Length (mm): 1300  
 Length (in): 51 <sup>3</sup>/<sub>16</sub>  
 Width (mm): 40  
 Width (in): 1 <sup>9</sup>/<sub>16</sub>  
 Height (mm): 40  
 Height (in): 1 <sup>9</sup>/<sub>16</sub>  
 Light Distribution: Indirect  
 Diffuser: Opal  
 Fixture Finish: WAL / ASH / OAK / BLK / WHI  
 Fixture Material: Wood

#### ELECTRICAL

Lamp Type: LED  
 Input Wattage (W): 29  
 Total Output Wattage (W): 25.4  
 Dimming: Tri-Mode (Non-Dimming and Phase Dimming (120Vac only) and 0-10V Dimming)  
 Driver Included: Yes  
 Driver Location: Remote  
 Driver Type: Constant Current - Universal  
 Driver Class: Class 2  
 Housing: ENCP1  
 Input Voltage (V): 120 - 277  
 Constant Current (MA): 700

#### LED

Color Temperature (°K): 2700 / 3000 / 4000  
 Max. Delivered Lumen (lm): 1550  
 CRI: >93 CRI  
 Lamp Life (hrs): 50000

#### OPTICAL

#### RATINGS AND CERTIFICATIONS

Certified By: Certified for North American Standards  
 IP rating: IP20



1300mm 51 <sup>3</sup>/<sub>16</sub>"

40mm 1 <sup>9</sup>/<sub>16</sub>"



Indirect



## LED40 SURFACE

D72021-

PROJECT

TYPE

SPECIFIER

QUANTITY

DATE



|           |
|-----------|
| PROJECT   |
| TYPE      |
| SPECIFIER |
| QUANTITY  |
| DATE      |

## LED40 SURFACE

### D72022-

base number                          
 Color            Temperature    Finish            Options

- To build a product code in our configurator select the specify button on the base model # product page
- To build a manual product code on this datasheet choose from the options listed below in blue font and add the suffix to the base model #

#### GENERAL

Series: Woodlin  
 Subseries: LED40  
 Brand: Tunto  
 Division: Design  
 Mounting Type: Surface  
 Mounting Location: Wall / Ceiling  
 Subcategory: Profile

#### PHYSICAL

Shape: Rectangle  
 Length (mm): 1600  
 Length (in): 63  
 Width (mm): 40  
 Width (in): 1 9/16  
 Height (mm): 40  
 Height (in): 1 9/16  
 Light Distribution: Indirect  
 Diffuser: Opal  
 Fixture Finish: [WAL / ASH / OAK / BLK / WHI](#)  
 Fixture Material: Wood

#### ELECTRICAL

Lamp Type: LED  
 Input Wattage (W): 35  
 Total Output Wattage (W): 31.5  
 Dimming: Tri-Mode (Non-Dimming and Phase Dimming (120Vac only) and 0-10V Dimming)  
 Driver Included: Yes  
 Driver Location: Remote  
 Driver Type: Constant Current - Universal  
 Driver Class: Class 2  
 Housing: ENCP1  
 Input Voltage (V): 120 - 277  
 Constant Current (MA): 700

#### LED

Color Temperature (°K): [2700 / 3000 / 4000](#)  
 Max. Delivered Lumen (lm): 2100  
 CRI: >93 CRI  
 Lamp Life (hrs): 50000

#### OPTICAL

#### RATINGS AND CERTIFICATIONS

Certified By: Certified for North American Standards  
 IP rating: IP20



1600mm 63"

40mm 1 9/16"



Indirect



## LED40 SURFACE

D72022-

PROJECT

TYPE

SPECIFIER

QUANTITY

DATE





## LED120 SURFACE

### D73027-

base number                                            
 Color                      Finish  
 Temperature              Options

- To build a product code in our configurator select the specify button on the base model # product page
- To build a manual product code on this datasheet choose from the options listed below in blue font and add the suffix to the base model #

#### GENERAL

Series: Woodlin  
 Subseries: LED120  
 Brand: Tunto  
 Division: Design  
 Mounting Type: Surface  
 Mounting Location: Wall  
 Subcategory: Profile

#### PHYSICAL

Shape: Rectangle  
 Length (mm): 200  
 Length (in): 7 <sup>7</sup>/<sub>8</sub>  
 Width (mm): 40  
 Width (in): 1 <sup>9</sup>/<sub>16</sub>  
 Height (mm): 120  
 Height (in): 4 <sup>3</sup>/<sub>4</sub>  
 Extension (mm): 40  
 Extension (in): 1 <sup>9</sup>/<sub>16</sub>  
 Light Distribution: Direct / Indirect  
 Diffuser: Opal  
 Fixture Finish: [WAL / ASH / OAK / BLK / WHI](#)  
 Fixture Material: Wood

#### ELECTRICAL

Lamp Type: LED  
 Input Wattage (W): 6  
 Total Output Wattage (W): 4.5  
 Dimming: Tri-Mode (Non-Dimming and Phase Dimming (120Vac only) and 0-10V Dimming)  
 Driver Included: Yes  
 Driver Location: Remote  
 Driver Type: Constant Current - Universal  
 Driver Class: Class 2  
 Housing: ENCP3  
 Input Voltage (V): 120 - 277  
 Constant Current (MA): 500

#### LED

Color Temperature (°K): [2700 / 3000 / 4000](#)  
 Max. Delivered Lumen (lm): 300  
 CRI: >93 CRI  
 Lamp Life (hrs): 50000

#### OPTICAL

#### RATINGS AND CERTIFICATIONS

Certified By: Certified for North American Standards  
 IP rating: IP20

|           |
|-----------|
| PROJECT   |
| TYPE      |
| SPECIFIER |
| QUANTITY  |
| DATE      |

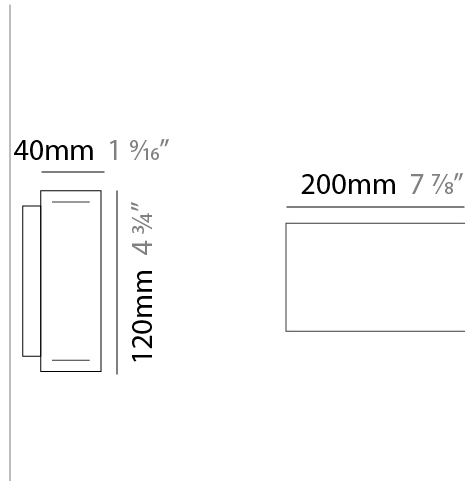

## LED120 SURFACE

D73027-

PROJECT

TYPE

SPECIFIER

QUANTITY

DATE



D

## LED120 SURFACE

**D73028-** -

base number                              
 Color                      Finish  
 Temperature            Options

- To build a product code in our configurator select the specify button on the base model # product page
- To build a manual product code on this datasheet choose from the options listed below in blue font and add the suffix to the base model #

### GENERAL

Series: Woodlin  
 Subseries: LED120  
 Brand: Tunto  
 Division: Design  
 Mounting Type: Surface  
 Mounting Location: Wall  
 Subcategory: Profile

### PHYSICAL

Shape: Rectangle  
 Length (mm): 400  
 Length (in): 15 ¾  
 Width (mm): 40  
 Width (in): 1 ⅙  
 Height (mm): 120  
 Height (in): 4 ¾  
 Extension (mm): 40  
 Extension (in): 1 ⅙  
 Light Distribution: Direct / Indirect  
 Diffuser: Opal  
 Fixture Finish: [WAL / ASH / OAK / BLK / WHI](#)  
 Fixture Material: Wood

### ELECTRICAL

Lamp Type: LED  
 Input Wattage (W): 16  
 Total Output Wattage (W): 12.6  
 Dimming: Tri-Mode (Non-Dimming and Phase Dimming (120Vac only) and 0-10V Dimming)  
 Driver Included: Yes  
 Driver Location: Remote  
 Driver Type: Constant Current - Universal  
 Driver Class: Class 2  
 Housing: ENCP3  
 Input Voltage (V): 120 - 277  
 Constant Current (MA): 700

### LED

Color Temperature (°K): [2700 / 3000 / 4000](#)  
 Max. Delivered Lumen (lm): 800  
 CRI: >93 CRI  
 Lamp Life (hrs): 50000

### OPTICAL

#### RATINGS AND CERTIFICATIONS

Certified By: Certified for North American Standards  
 IP rating: IP20

|           |
|-----------|
| PROJECT   |
| TYPE      |
| SPECIFIER |
| QUANTITY  |
| DATE      |

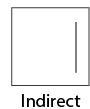

## LED120 SURFACE

D73028-

PROJECT

TYPE

SPECIFIER

QUANTITY

DATE



D

## LED120 SURFACE

### D73029-

base number                                            
 Color                      Finish  
 Temperature              Options

- To build a product code in our configurator select the specify button on the base model # product page
- To build a manual product code on this datasheet choose from the options listed below in blue font and add the suffix to the base model #

#### GENERAL

Series: Woodlin  
 Subseries: LED120  
 Brand: Tunto  
 Division: Design  
 Mounting Type: Surface  
 Mounting Location: Wall  
 Subcategory: Profile

#### PHYSICAL

Shape: Rectangle  
 Length (mm): 700  
 Length (in): 27 <sup>9</sup>/<sub>16</sub>  
 Width (mm): 40  
 Width (in): 1 <sup>9</sup>/<sub>16</sub>  
 Height (mm): 120  
 Height (in): 4 <sup>3</sup>/<sub>4</sub>  
 Extension (mm): 40  
 Extension (in): 1 <sup>9</sup>/<sub>16</sub>  
 Light Distribution: Direct / Indirect  
 Diffuser: Opal  
 Fixture Finish: [WAL / ASH / OAK / BLK / WHI](#)  
 Fixture Material: Wood

#### ELECTRICAL

Lamp Type: LED  
 Input Wattage (W): 31  
 Total Output Wattage (W): 25.3  
 Dimming: Tri-Mode (Non-Dimming and Phase Dimming (120Vac only) and 0-10V Dimming)  
 Driver Included: Yes  
 Driver Location: Remote  
 Driver Type: Constant Current - Universal  
 Driver Class: Class 2  
 Housing: ENCP3  
 Input Voltage (V): 120 - 277  
 Constant Current (MA): 700

#### LED

[Color Temperature \(°K\): 2700 / 3000 / 4000](#)  
 Max. Delivered Lumen (lm): 1500  
 CRI: >93 CRI  
 Lamp Life (hrs): 50000

#### OPTICAL

#### RATINGS AND CERTIFICATIONS

Certified By: Certified for North American Standards  
 IP rating: IP20

|           |
|-----------|
| PROJECT   |
| TYPE      |
| SPECIFIER |
| QUANTITY  |
| DATE      |

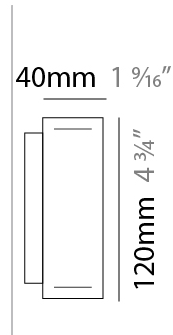

700mm 27 <sup>9</sup>/<sub>16</sub>"



Indirect



## LED120 SURFACE

D73029-

PROJECT

TYPE

SPECIFIER

QUANTITY

DATE



D

|           |       |
|-----------|-------|
| PROJECT   | _____ |
| TYPE      | _____ |
| SPECIFIER | _____ |
| QUANTITY  | _____ |
| DATE      | _____ |

### Fixture Finish

Walnut Natural - WAL



Ash White Oil Waxed - ASH



Oak Natural - OAK



Black - BLK



White - WHI

**Digital:** Not all screens are calibrated the same, and therefore, colors will appear differently between screens.

**Physical:** When texture is involved, there will be variations in color, character and tone within a product series and between product families.











Wood is a living, organic material. Hence, the patterns and hues can vary, and can change as the material ages. We are not responsible for any natural material transformation and development.



### LEGEND

|  |   |   |  |   |  |
|--|---|---|--|---|--|
|    | floor-mounted   |    | pivotal  |    | special LED (upon request) RGB, RGBW, tunable, gold+, meat+, art+, fashion+                    |
|    | wall and ceiling: recessed and surface mounted            |    | rotating   |    | warm dim / natural dimming LED   |
|    | ceiling-mounted and wall-mounted                          |    | illuminate tilted  |    | rechargeable battery powered   |
|    | wall-mounted  |    | color of suspension cable                                    |    | fixture with natural vivid LED (upon request)  |
|    | omni-directional light distribution                       |    | length of suspension cable                                   |    | color rendering index  |
|    | direct light distribution                                 |    | reflector degree selection                                   |    | color temperature  |
|    | direct/indirect light distribution                        |    | super spot   |    | lumen (luminous flux)  |
|    | indirect light distribution                               |    | lens   |    | efficacy (lumens per watt)   |
|    | asymmetric light distribution                             |    | lens pack  |    | Unified Glare Rating (UGR) range from 5-40   |
|    | aura light distribution                                   |    | shine ring   |    | marine grade (AISI 316 stainless steel)  |
|    | round wall or ceiling cut-out                             |    | integrated shine ring with diffuser                          |    | walk on  |
|    | square wall or ceiling cut-out                            |    | free individual colors 01-29                                 |    | drive on   |
|    | the supplied jig specifies the cutout dimensions          |    | individual colors: 00 (free of charge), 01-25 (extra charge) |    | Dark Sky Compliance  |
|    | minimum distance (meters) lamp - object                   |    | luminaire part to be colored (F1)                            |    | Americans with Disabilities Act (less than 4" off the wall located between 27"-84" from floor) |
|    | recessed depth  |    | luminaire part to be colored (F2)                            |    | lamp protected against explosion   |
|   | ceiling thickness in mm                                   |   | luminaire part to be colored (F3)                            |   | blown glass using traditional methods by master glass blower                                   |
|  | ceiling thickness selection                               |  | luminaire part to be colored (F4)                            |  | acoustic material  |
|  | dimnable DP (phase), DV (0-10V), DD (dali), DS (step-dim) |  | luminaire part to be colored (F5)                            |  | protection class I, protection insulation  |
|  | included or excluded LED driver/transformer/control gear  |  | color of 3-circuit adaptor                                   |  | protection class II, protection insulation   |
|  | separately switchable                                     |  | indirect diffuser  |  | ETL Certified to UL and CSA Standards  |
|  | sensor  |  | direct diffuser  |  | UL Certified to UL and CSA Standards   |
|  | remote control  |  | ball-proof (upon request)                                    |  | CSA Certified to UL and CSA Standards  |
|  | available upon request                                    |  | accessory  |  | Certified for North American Standards   |

### IP RATING

|   |  |
|---|--|
|  | protected against ingress of solid bodies greater than 12.5mm (finger)   |
|  | protected against ingress of solid bodies greater than 2.5mm<br>protected against sprays of water up to 60 degrees from the vertical (rain)      |
|  | protected against ingress of solid bodies greater than 1mm (wire)<br>no protection against the ingress of moisture                               |
|  | protected against ingress of solid bodies greater than 1mm (wire)<br>protected against sprays of water up to 60 degrees from the vertical (rain) |
|  | protected against ingress of solid bodies greater than 1mm (wire)<br>protected against water splashed from all directions                        |
|  | protected against limited ingress of dust (wet rooms/covered outdoor areas)<br>protected against water splashed from all directions              |
|  | protected against ingress of dust<br>protected against jets of water   |
|  | protected against ingress of dust<br>protected against powerful jets of water or heavy seas  |
|  | protected against ingress of dust<br>protected against immersion of water between 15cm - 1m for 30 minutes                                       |
|  | protected against ingress of dust<br>protected against immersion of water under pressure for long periods  |

### IK RATING

|   |   |
|---|---|
|  | protected against 0.14 joules impact (equivalent to 0.25kg mass dropped from 56mm above the surface)  |
|  | protected against 0.2 joules impact (equivalent to 0.25kg mass dropped from 80mm above the surface)   |
|  | protected against 0.35 joules impact (equivalent to 0.25kg mass dropped from 140mm above the surface) |
|  | protected against 0.5 joules impact (equivalent to 0.25kg mass dropped from 200mm above the surface)  |
|  | protected against 0.7 joules impact (equivalent to 0.25kg mass dropped from 280mm above the surface)  |
|  | protected against 1 joules impact (equivalent to 0.25kg mass dropped from 400mm above the surface)    |
|  | protected against 2 joules impact (equivalent to 0.5kg mass dropped from 400mm above the surface)     |
|  | protected against 5 joules impact (equivalent to 1.7kg mass dropped from 300mm above the surface)     |
|  | protected against 10 joules impact (equivalent to 5.0kg mass dropped from 200mm above the surface)    |
|  | protected against 20 joules impact (equivalent to 5.0kg mass dropped from 400mm above the surface)    |