

LED40 SURFACE

D72005-

base number Color Finish
Temperature Options

- To build a product code in our configurator select the specify button on the base model # product page
- To build a manual product code on this datasheet choose from the options listed below in blue font and add the suffix to the base model #

GENERAL

Series: Woodlin
Subseries: LED40
Brand: Tunto
Division: Design
Mounting Type: Surface
Mounting Location: Ceiling
Subcategory: Sconce

PHYSICAL

Shape: Rectangle
Length (mm): 400
Length (in): 15 $\frac{3}{4}$ "
Width (mm): 40
Width (in): 1 $\frac{9}{16}$ "
Height (mm): 40
Height (in): 1 $\frac{9}{16}$ "
Light Distribution: Direct
Diffuser: Opal
Fixture Finish: WAL / ASH / OAK / BLK / WHI
Fixture Material: Wood

ELECTRICAL

Lamp Type: LED
Input Wattage (W): 9
Total Output Wattage (W): 6.3
Dimming: Tri-Mode (Non-Dimming and Phase Dimming (120Vac only) and 0-10V Dimming)
Driver Included: Yes
Driver Location: Remote
Driver Type: Constant Current - Universal
Driver Class: Class 2
Housing: ENCP3
Input Voltage (V): 120 - 277
Constant Current (MA): 700

LED

Color Temperature (°K): 2700 / 3000 / 4000
Max. Delivered Lumen (lm): 480
CRI: >93 CRI
Lamp Life (hrs): 50000

OPTICAL

RATINGS AND CERTIFICATIONS

Certified By: Certified for North American Standards
IP rating: IP20



400mm 15 $\frac{3}{4}$ "

40mm 1 $\frac{9}{16}$ "



Direct



LED40 SURFACE

D72005-

PROJECT

TYPE

SPECIFIER

QUANTITY

DATE



D

PROJECT
TYPE
SPECIFIER
QUANTITY
DATE

LED40 SURFACE

D72006-

base number
 Color Finish
 Temperature Options

- To build a product code in our configurator select the specify button on the base model # product page
- To build a manual product code on this datasheet choose from the options listed below in blue font and add the suffix to the base model #

GENERAL

Series: Woodlin
 Subseries: LED40
 Brand: Tunto
 Division: Design
 Mounting Type: Surface
 Mounting Location: Ceiling
 Subcategory: Sconce

PHYSICAL

Shape: Rectangle
 Length (mm): 700
 Length (in): 27 ⁹/₁₆
 Width (mm): 40
 Width (in): 1 ⁹/₁₆
 Height (mm): 40
 Height (in): 1 ⁹/₁₆
 Light Distribution: Direct
 Diffuser: Opal
 Fixture Finish: WAL / ASH / OAK / BLK / WHI
 Fixture Material: Wood

ELECTRICAL

Lamp Type: LED
 Input Wattage (W): 16
 Total Output Wattage (W): 12.6
 Dimming: Tri-Mode (Non-Dimming and Phase Dimming (120Vac only) and 0-10V Dimming)
 Driver Included: Yes
 Driver Location: Remote
 Driver Type: Constant Current - Universal
 Driver Class: Class 2
 Housing: ENCP3
 Input Voltage (V): 120 - 277
 Constant Current (MA): 700

LED

Color Temperature (°K): 2700 / 3000 / 4000
 Max. Delivered Lumen (lm): 960
 CRI: >93 CRI
 Lamp Life (hrs): 50000

OPTICAL

RATINGS AND CERTIFICATIONS

Certified By: Certified for North American Standards
 IP rating: IP20

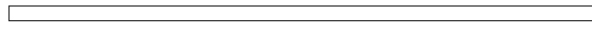

700mm 27 ⁹/₁₆"

40mm 1 ⁹/₁₆"



Direct



LED40 SURFACE

D72006-

PROJECT

TYPE

SPECIFIER

QUANTITY

DATE



D

PROJECT
TYPE
SPECIFIER
QUANTITY
DATE

LED40 SURFACE

D72007-

base number
 Color Finish
 Temperature Options

- To build a product code in our configurator select the specify button on the base model # product page
- To build a manual product code on this datasheet choose from the options listed below in blue font and add the suffix to the base model #

GENERAL

Series: Woodlin
 Subseries: LED40
 Brand: Tunto
 Division: Design
 Mounting Type: Surface
 Mounting Location: Ceiling
 Subcategory: Sconce

PHYSICAL

Shape: Rectangle
 Length (mm): 1000
 Length (in): 39 ³/₈
 Width (mm): 40
 Width (in): 1 ⁹/₁₆
 Height (mm): 40
 Height (in): 1 ⁹/₁₆
 Light Distribution: Direct
 Diffuser: Opal
 Fixture Finish: WAL / ASH / OAK / BLK / WHI
 Fixture Material: Wood

ELECTRICAL

Lamp Type: LED
 Input Wattage (W): 23
 Total Output Wattage (W): 19
 Dimming: Tri-Mode (Non-Dimming and Phase Dimming (120Vac only) and 0-10V Dimming)
 Driver Included: Yes
 Driver Location: Remote
 Driver Type: Constant Current - Universal
 Driver Class: Class 2
 Housing: ENCP1
 Input Voltage (V): 120 - 277
 Constant Current (MA): 700

LED

Color Temperature (°K): 2700 / 3000 / 4000
 Max. Delivered Lumen (lm): 1300
 CRI: >93 CRI
 Lamp Life (hrs): 50000

OPTICAL

RATINGS AND CERTIFICATIONS

Certified By: Certified for North American Standards
 IP rating: IP20



1000mm 39 ³/₈"

40mm 1 ⁹/₁₆"



Direct



LED40 SURFACE

D72007-

PROJECT

TYPE

SPECIFIER

QUANTITY

DATE



D

PROJECT
TYPE
SPECIFIER
QUANTITY
DATE

LED40 SURFACE

D72008-

base number
 Color Finish
 Temperature Options

- To build a product code in our configurator select the specify button on the base model # product page
- To build a manual product code on this datasheet choose from the options listed below in blue font and add the suffix to the base model #

GENERAL

Series: Woodlin
 Subseries: LED40
 Brand: Tunto
 Division: Design
 Mounting Type: Surface
 Mounting Location: Ceiling
 Subcategory: Sconce

PHYSICAL

Shape: Rectangle
 Length (mm): 1300
 Length (in): 51 ³/₁₆
 Width (mm): 40
 Width (in): 1 ⁹/₁₆
 Height (mm): 40
 Height (in): 1 ⁹/₁₆
 Light Distribution: Direct
 Diffuser: Opal
 Fixture Finish: WAL / ASH / OAK / BLK / WHI
 Fixture Material: Wood

ELECTRICAL

Lamp Type: LED
 Input Wattage (W): 29
 Total Output Wattage (W): 25.4
 Dimming: Tri-Mode (Non-Dimming and Phase Dimming (120Vac only) and 0-10V Dimming)
 Driver Included: Yes
 Driver Location: Remote
 Driver Type: Constant Current - Universal
 Driver Class: Class 2
 Housing: ENCP1
 Input Voltage (V): 120 - 277
 Constant Current (MA): 700

LED

Color Temperature (°K): 2700 / 3000 / 4000
 Max. Delivered Lumen (lm): 1550
 CRI: >93 CRI
 Lamp Life (hrs): 50000

OPTICAL

RATINGS AND CERTIFICATIONS

Certified By: Certified for North American Standards
 IP rating: IP20

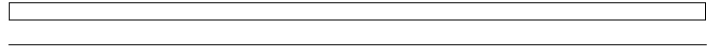

1300mm 51 ³/₁₆"

40mm 1 ⁹/₁₆"



Direct



LED40 SURFACE

D72008-

PROJECT

TYPE

SPECIFIER

QUANTITY

DATE



D

PROJECT
TYPE
SPECIFIER
QUANTITY
DATE

LED40 SURFACE

D72009-

base number
 Color Finish
 Temperature Options

- To build a product code in our configurator select the specify button on the base model # product page
- To build a manual product code on this datasheet choose from the options listed below in blue font and add the suffix to the base model #

GENERAL

Series: Woodlin
 Subseries: LED40
 Brand: Tunto
 Division: Design
 Mounting Type: Surface
 Mounting Location: Ceiling
 Subcategory: Sconce

PHYSICAL

Shape: Rectangle
 Length (mm): 1600
 Length (in): 63
 Width (mm): 40
 Width (in): 1 9/16
 Height (mm): 40
 Height (in): 1 9/16
 Light Distribution: Direct
 Diffuser: Opal
 Fixture Finish: [WAL / ASH / OAK / BLK / WHI](#)
 Fixture Material: Wood

ELECTRICAL

Lamp Type: LED
 Input Wattage (W): 35
 Total Output Wattage (W): 31.5
 Dimming: Tri-Mode (Non-Dimming and Phase Dimming (120Vac only) and 0-10V Dimming)
 Driver Included: Yes
 Driver Location: Remote
 Driver Type: Constant Current - Universal
 Driver Class: Class 2
 Housing: ENCP1
 Input Voltage (V): 120 - 277
 Constant Current (MA): 700

LED

Color Temperature (°K): [2700 / 3000 / 4000](#)
 Max. Delivered Lumen (lm): 2100
 CRI: >93 CRI
 Lamp Life (hrs): 50000

OPTICAL

RATINGS AND CERTIFICATIONS

Certified By: Certified for North American Standards
 IP rating: IP20



1600mm 63"

40mm 1 9/16"



Direct



LED40 SURFACE

D72009-

PROJECT

TYPE

SPECIFIER

QUANTITY

DATE



D

LED28 SURFACE

D72012-

base number
Color Finish
Temperature Options

- To build a product code in our configurator select the specify button on the base model # product page
- To build a manual product code on this datasheet choose from the options listed below in blue font and add the suffix to the base model #

GENERAL

Series: Woodlin
Subseries: LED28
Brand: Tunto
Division: Design
Mounting Type: Surface
Mounting Location: Ceiling
Subcategory: Sconce

PHYSICAL

Shape: Rectangle
Length (mm): 1000
Length (in): 39 ³/₈
Width (mm): 28
Width (in): 1 ¹/₈
Height (mm): 28
Height (in): 1 ¹/₈
Light Distribution: Direct
Diffuser: Opal
Fixture Finish: WAL / ASH / OAK / BLK / WHI
Fixture Material: Wood

ELECTRICAL

Lamp Type: LED
Input Wattage (W): 21
Total Output Wattage (W): 19
Dimming: Tri-Mode (Non-Dimming and Phase Dimming (120Vac only) and 0-10V Dimming)
Driver Included: Yes
Driver Location: Remote
Driver Type: Constant Current - Universal
Driver Class: Class 2
Housing: ENCP1
Input Voltage (V): 120 - 277
Constant Current (MA): 700

LED

Color Temperature (°K): 2700 / 3000 / 4000
Max. Delivered Lumen (lm): 1200
CRI: >93 CRI
Lamp Life (hrs): 50000

OPTICAL

RATINGS AND CERTIFICATIONS

Certified By: Certified for North American Standards
IP rating: IP20

PROJECT	_____
TYPE	_____
SPECIFIER	_____
QUANTITY	_____
DATE	_____



1000mm 39 ³/₈"

28mm 1 ¹/₈"



Direct



LED28 SURFACE

D72012-

PROJECT

TYPE

SPECIFIER

QUANTITY

DATE



LED28 SURFACE

D72013-

base number Color Finish
Temperature Options

- To build a product code in our configurator select the specify button on the base model # product page
- To build a manual product code on this datasheet choose from the options listed below in blue font and add the suffix to the base model #

GENERAL

Series: Woodlin
Subseries: LED28
Brand: Tunto
Division: Design
Mounting Type: Surface
Mounting Location: Ceiling
Subcategory: Sconce

PHYSICAL

Shape: Rectangle
Length (mm): 1200
Length (in): 47 1/4
Width (mm): 28
Width (in): 1 1/8
Height (mm): 28
Height (in): 1 1/8
Light Distribution: Direct
Diffuser: Opal
Fixture Finish: WAL / ASH / OAK / BLK / WHI
Fixture Material: Wood

ELECTRICAL

Lamp Type: LED
Input Wattage (W): 25
Total Output Wattage (W): 23.5
Dimming: Tri-Mode (Non-Dimming and Phase Dimming (120Vac only) and 0-10V Dimming)
Driver Included: Yes
Driver Location: Remote
Driver Type: Constant Current - Universal
Driver Class: Class 2
Housing: ENCP1
Input Voltage (V): 120 - 277
Constant Current (MA): 700

LED

Color Temperature (°K): 2700 / 3000 / 4000
Max. Delivered Lumen (lm): 1400
CRI: >93 CRI
Lamp Life (hrs): 50000

OPTICAL

RATINGS AND CERTIFICATIONS

Certified By: Certified for North American Standards
IP rating: IP20

PROJECT	_____
TYPE	_____
SPECIFIER	_____
QUANTITY	_____
DATE	_____



1200mm 47 1/4"

28mm 1 1/8"



Direct



LED28 SURFACE

D72013-

PROJECT

TYPE

SPECIFIER

QUANTITY

DATE



LED60 SURFACE

D72014-

base number
Color Finish
Temperature Options

- To build a product code in our configurator select the specify button on the base model # product page
- To build a manual product code on this datasheet choose from the options listed below in blue font and add the suffix to the base model #

GENERAL

Series: Woodlin
Subseries: LED60
Brand: Tunto
Division: Design
Mounting Type: Surface
Mounting Location: Ceiling
Subcategory: Sconce

PHYSICAL

Shape: Rectangle
Length (mm): 400
Length (in): 15 ³/₄
Width (mm): 60
Width (in): 2 ³/₈
Height (mm): 60
Height (in): 2 ³/₈
Light Distribution: Direct
Diffuser: Opal
Fixture Finish: WAL / ASH / OAK / BLK / WHI
Fixture Material: Wood

ELECTRICAL

Lamp Type: LED
Input Wattage (W): 16
Total Output Wattage (W): 12.6
Dimming: Tri-Mode (Non-Dimming and Phase Dimming (120Vac only) and 0-10V Dimming)
Driver Included: Yes
Driver Location: Remote
Driver Type: Constant Current - Universal
Driver Class: Class 2
Housing: ENCP1
Input Voltage (V): 120 - 277
Constant Current (MA): 700

LED

Color Temperature (°K): 2700 / 3000 / 4000
Max. Delivered Lumen (lm): 1080
CRI: >93 CRI
Lamp Life (hrs): 50000

OPTICAL

RATINGS AND CERTIFICATIONS

Certified By: Certified for North American Standards
IP rating: IP20

PROJECT	_____
TYPE	_____
SPECIFIER	_____
QUANTITY	_____
DATE	_____



400mm 15 ³/₄"

60mm 2 ³/₈"



Direct



LED60 SURFACE

D72014-

PROJECT

TYPE

SPECIFIER

QUANTITY

DATE



LED60 SURFACE

D72015-

base number
Color Finish
Temperature Options

- To build a product code in our configurator select the specify button on the base model # product page
- To build a manual product code on this datasheet choose from the options listed below in blue font and add the suffix to the base model #

GENERAL

Series: Woodlin
Subseries: LED60
Brand: Tunto
Division: Design
Mounting Type: Surface
Mounting Location: Ceiling
Subcategory: Sconce

PHYSICAL

Shape: Rectangle
Length (mm): 700
Length (in): 27 ⁵/₁₆
Width (mm): 60
Width (in): 2 ³/₈
Height (mm): 60
Height (in): 2 ³/₈
Light Distribution: Direct
Diffuser: Opal
Fixture Finish: WAL / ASH / OAK / BLK / WHI
Fixture Material: Wood

ELECTRICAL

Lamp Type: LED
Input Wattage (W): 30
Total Output Wattage (W): 25.3
Dimming: Tri-Mode (Non-Dimming and Phase Dimming (120Vac only) and 0-10V Dimming)
Driver Included: Yes
Driver Location: Remote
Driver Type: Constant Current - Universal
Driver Class: Class 2
Housing: ENCP1
Input Voltage (V): 120 - 277
Constant Current (MA): 700

LED

Color Temperature (°K): 2700 / 3000 / 4000
Max. Delivered Lumen (lm): 2180
CRI: >93 CRI
Lamp Life (hrs): 50000

OPTICAL

RATINGS AND CERTIFICATIONS

Certified By: Certified for North American Standards
IP rating: IP20

PROJECT	_____
TYPE	_____
SPECIFIER	_____
QUANTITY	_____
DATE	_____



700mm 27 ⁵/₁₆"

60mm 2 ³/₈"



Direct



LED60 SURFACE

D72015-

PROJECT

TYPE

SPECIFIER

QUANTITY

DATE



LED60 SURFACE

D72016-

base number
 Color Finish
 Temperature Options

- To build a product code in our configurator select the specify button on the base model # product page
- To build a manual product code on this datasheet choose from the options listed below in blue font and add the suffix to the base model #

GENERAL

Series: Woodlin
 Subseries: LED60
 Brand: Tunto
 Division: Design
 Mounting Type: Surface
 Mounting Location: Wall
 Subcategory: Sconce

PHYSICAL

Shape: Rectangle
 Length (mm): 400
 Length (in): 15 3/4
 Width (mm): 60
 Width (in): 2 3/8
 Height (mm): 60
 Height (in): 2 3/8
 Light Distribution: Indirect
 Diffuser: Opal
 Fixture Finish: WAL / ASH / OAK / BLK / WHI
 Fixture Material: Wood

ELECTRICAL

Lamp Type: LED
 Input Wattage (W): 16
 Total Output Wattage (W): 12.6
 Dimming: Tri-Mode (Non-Dimming and Phase Dimming (120Vac only) and 0-10V Dimming)
 Driver Included: Yes
 Driver Location: Remote
 Driver Type: Constant Current - Universal
 Driver Class: Class 2
 Housing: ENCP3
 Input Voltage (V): 120 - 277
 Constant Current (MA): 700

LED

Color Temperature (°K): 2700 / 3000 / 4000
 Max. Delivered Lumen (lm): 1080
 CRI: >93 CRI
 Lamp Life (hrs): 50000

OPTICAL

RATINGS AND CERTIFICATIONS

Certified By: Certified for North American Standards
 IP rating: IP20

PROJECT
TYPE
SPECIFIER
QUANTITY
DATE



400mm 15 3/4"

60mm 2 3/8"



Direct



LED60 SURFACE

D72016-

PROJECT

TYPE

SPECIFIER

QUANTITY

DATE



LED60 SURFACE

D72017-

base number
Color Finish
Temperature Options

- To build a product code in our configurator select the specify button on the base model # product page
- To build a manual product code on this datasheet choose from the options listed below in blue font and add the suffix to the base model #

GENERAL

Series: Woodlin
Subseries: LED60
Brand: Tunto
Division: Design
Mounting Type: Surface
Mounting Location: Wall
Subcategory: Sconce

PHYSICAL

Shape: Rectangle
Length (mm): 700
Length (in): 27 ⁵/₁₆
Width (mm): 60
Width (in): 2 ³/₈
Height (mm): 60
Height (in): 2 ³/₈
Light Distribution: Indirect
Diffuser: Opal
Fixture Finish: WAL / ASH / OAK / BLK / WHI
Fixture Material: Wood

ELECTRICAL

Lamp Type: LED
Input Wattage (W): 28
Total Output Wattage (W): 24
Dimming: Tri-Mode (Non-Dimming and Phase Dimming (120Vac only) and 0-10V Dimming)
Driver Included: Yes
Driver Location: Remote
Driver Type: Constant Current - Universal
Driver Class: Class 2
Housing: ENCP1
Input Voltage (V): 120 - 277
Constant Current (MA): 700

LED

Color Temperature (°K): 2700 / 3000 / 4000
Max. Delivered Lumen (lm): 2180
CRI: >93 CRI
Lamp Life (hrs): 50000

OPTICAL

RATINGS AND CERTIFICATIONS

Certified By: Certified for North American Standards
IP rating: IP20

PROJECT	_____
TYPE	_____
SPECIFIER	_____
QUANTITY	_____
DATE	_____



700mm 27 ⁵/₁₆"

60mm 2 ³/₈"



Indirect



LED60 SURFACE

D72017-

PROJECT

TYPE

SPECIFIER

QUANTITY

DATE



PROJECT	_____
TYPE	_____
SPECIFIER	_____
QUANTITY	_____
DATE	_____

LED40 SURFACE

D72018-

base number
Color Temperature Finish Options

- To build a product code in our configurator select the specify button on the base model # product page
- To build a manual product code on this datasheet choose from the options listed below in blue font and add the suffix to the base model #

GENERAL

Series: Woodlin
Subseries: LED40
Brand: Tunto
Division: Design
Mounting Type: Surface
Mounting Location: Wall
Subcategory: Sconce

PHYSICAL

Shape: Rectangle
Length (mm): 400
Length (in): 15 3/4
Width (mm): 40
Width (in): 1 9/16
Height (mm): 40
Height (in): 1 9/16
Light Distribution: Indirect
Diffuser: Opal
Fixture Finish: WAL / ASH / OAK / BLK / WHI
Fixture Material: Wood

ELECTRICAL

Lamp Type: LED
Input Wattage (W): 9
Total Output Wattage (W): 6.3
Dimming: Tri-Mode (Non-Dimming and Phase Dimming (120Vac only) and 0-10V Dimming)
Driver Included: Yes
Driver Location: Remote
Driver Type: Constant Current - Universal
Driver Class: Class 2
Housing: ENCP3
Input Voltage (V): 120 - 277
Constant Current (MA): 700

LED

Color Temperature (°K): 2700 / 3000 / 4000
Max. Delivered Lumen (lm): 480
CRI: >93 CRI
Lamp Life (hrs): 50000

OPTICAL

RATINGS AND CERTIFICATIONS

Certified By: Certified for North American Standards
IP rating: IP20

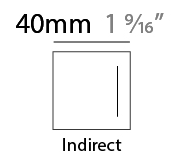
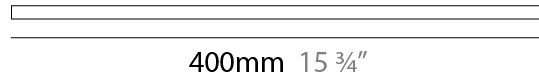

LED40 SURFACE

D72018-

PROJECT

TYPE

SPECIFIER

QUANTITY

DATE



PROJECT
TYPE
SPECIFIER
QUANTITY
DATE

LED40 SURFACE

D72019-

base number
 Color Finish
 Temperature Options

- To build a product code in our configurator select the specify button on the base model # product page
- To build a manual product code on this datasheet choose from the options listed below in blue font and add the suffix to the base model #

GENERAL

Series: Woodlin
 Subseries: LED40
 Brand: Tunto
 Division: Design
 Mounting Type: Surface
 Mounting Location: Wall
 Subcategory: Sconce

PHYSICAL

Shape: Rectangle
 Length (mm): 700
 Length (in): 27 ⁹/₁₆
 Width (mm): 40
 Width (in): 1 ⁹/₁₆
 Height (mm): 40
 Height (in): 1 ⁹/₁₆
 Light Distribution: Indirect
 Diffuser: Opal
 Fixture Finish: WAL / ASH / OAK / BLK / WHI
 Fixture Material: Wood

ELECTRICAL

Lamp Type: LED
 Input Wattage (W): 16
 Total Output Wattage (W): 12.6
 Dimming: Tri-Mode (Non-Dimming and Phase Dimming (120Vac only) and 0-10V Dimming)
 Driver Included: Yes
 Driver Location: Remote
 Driver Type: Constant Current - Universal
 Driver Class: Class 2
 Housing: ENCP3
 Input Voltage (V): 120 - 277
 Constant Current (MA): 700

LED

Color Temperature (°K): 2700 / 3000 / 4000
 Max. Delivered Lumen (lm): 960
 CRI: >93 CRI
 Lamp Life (hrs): 50000

OPTICAL

RATINGS AND CERTIFICATIONS

Certified By: Certified for North American Standards
 IP rating: IP20

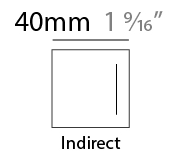
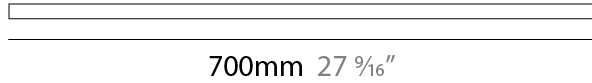

LED40 SURFACE

D72019-

PROJECT

TYPE

SPECIFIER

QUANTITY

DATE



PROJECT
TYPE
SPECIFIER
QUANTITY
DATE

LED40 SURFACE

D72020-

base number
 Color Finish
 Temperature Options

- To build a product code in our configurator select the specify button on the base model # product page
- To build a manual product code on this datasheet choose from the options listed below in blue font and add the suffix to the base model #

GENERAL

Series: Woodlin
 Subseries: LED40
 Brand: Tunto
 Division: Design
 Mounting Type: Surface
 Mounting Location: Wall
 Subcategory: Sconce

PHYSICAL

Shape: Rectangle
 Length (mm): 1000
 Length (in): 39 ³/₈
 Width (mm): 40
 Width (in): 1 ⁹/₁₆
 Height (mm): 40
 Height (in): 1 ⁹/₁₆
 Light Distribution: Indirect
 Diffuser: Opal
 Fixture Finish: WAL / ASH / OAK / BLK / WHI
 Fixture Material: Wood

ELECTRICAL

Lamp Type: LED
 Input Wattage (W): 23
 Total Output Wattage (W): 19
 Dimming: Tri-Mode (Non-Dimming and Phase Dimming (120Vac only) and 0-10V Dimming)
 Driver Included: Yes
 Driver Location: Remote
 Driver Type: Constant Current - Universal
 Driver Class: Class 2
 Housing: ENCP1
 Input Voltage (V): 120 - 277
 Constant Current (MA): 700

LED

Color Temperature (°K): 2700 / 3000 / 4000
 Max. Delivered Lumen (lm): 1300
 CRI: >93 CRI
 Lamp Life (hrs): 50000

OPTICAL

RATINGS AND CERTIFICATIONS

Certified By: Certified for North American Standards
 IP rating: IP20



1000mm 39 ³/₈"

40mm 1 ⁹/₁₆"



Indirect



LED40 SURFACE

D72020-

PROJECT

TYPE

SPECIFIER

QUANTITY

DATE



PROJECT
TYPE
SPECIFIER
QUANTITY
DATE

LED40 SURFACE

D72021-

base number
 Color Finish
 Temperature Options

- To build a product code in our configurator select the specify button on the base model # product page
- To build a manual product code on this datasheet choose from the options listed below in blue font and add the suffix to the base model #

GENERAL

Series: Woodlin
 Subseries: LED40
 Brand: Tunto
 Division: Design
 Mounting Type: Surface
 Mounting Location: Wall
 Subcategory: Sconce

PHYSICAL

Shape: Rectangle
 Length (mm): 1300
 Length (in): 51 ³/₁₆
 Width (mm): 40
 Width (in): 1 ⁹/₁₆
 Height (mm): 40
 Height (in): 1 ⁹/₁₆
 Light Distribution: Indirect
 Diffuser: Opal
 Fixture Finish: WAL / ASH / OAK / BLK / WHI
 Fixture Material: Wood

ELECTRICAL

Lamp Type: LED
 Input Wattage (W): 29
 Total Output Wattage (W): 25.4
 Dimming: Tri-Mode (Non-Dimming and Phase Dimming (120Vac only) and 0-10V Dimming)
 Driver Included: Yes
 Driver Location: Remote
 Driver Type: Constant Current - Universal
 Driver Class: Class 2
 Housing: ENCP1
 Input Voltage (V): 120 - 277
 Constant Current (MA): 700

LED

Color Temperature (°K): 2700 / 3000 / 4000
 Max. Delivered Lumen (lm): 1550
 CRI: >93 CRI
 Lamp Life (hrs): 50000

OPTICAL

RATINGS AND CERTIFICATIONS

Certified By: Certified for North American Standards
 IP rating: IP20



1300mm 51 ³/₁₆"

40mm 1 ⁹/₁₆"



Indirect



LED40 SURFACE

D72021-

PROJECT

TYPE

SPECIFIER

QUANTITY

DATE



PROJECT
TYPE
SPECIFIER
QUANTITY
DATE

LED40 SURFACE

D72022-

base number
 Color Temperature Finish Options

- To build a product code in our configurator select the specify button on the base model # product page
- To build a manual product code on this datasheet choose from the options listed below in blue font and add the suffix to the base model #

GENERAL

Series: Woodlin
 Subseries: LED40
 Brand: Tunto
 Division: Design
 Mounting Type: Surface
 Mounting Location: Wall
 Subcategory: Sconce

PHYSICAL

Shape: Rectangle
 Length (mm): 1600
 Length (in): 63
 Width (mm): 40
 Width (in): 1 9/16
 Height (mm): 40
 Height (in): 1 9/16
 Light Distribution: Indirect
 Diffuser: Opal
 Fixture Finish: [WAL / ASH / OAK / BLK / WHI](#)
 Fixture Material: Wood

ELECTRICAL

Lamp Type: LED
 Input Wattage (W): 35
 Total Output Wattage (W): 31.5
 Dimming: Tri-Mode (Non-Dimming and Phase Dimming (120Vac only) and 0-10V Dimming)
 Driver Included: Yes
 Driver Location: Remote
 Driver Type: Constant Current - Universal
 Driver Class: Class 2
 Housing: ENCP1
 Input Voltage (V): 120 - 277
 Constant Current (MA): 700

LED

Color Temperature (°K): [2700 / 3000 / 4000](#)
 Max. Delivered Lumen (lm): 2100
 CRI: >93 CRI
 Lamp Life (hrs): 50000

OPTICAL

RATINGS AND CERTIFICATIONS

Certified By: Certified for North American Standards
 IP rating: IP20



1600mm 63"

40mm 1 9/16"



Indirect



LED40 SURFACE

D72022-

PROJECT

TYPE

SPECIFIER

QUANTITY

DATE



LED120 SURFACE

D73027-

base number
 Color Finish
 Temperature Options

- To build a product code in our configurator select the specify button on the base model # product page
- To build a manual product code on this datasheet choose from the options listed below in blue font and add the suffix to the base model #

GENERAL

Series: Woodlin
 Subseries: LED120
 Brand: Tunto
 Division: Design
 Mounting Type: Surface
 Mounting Location: Wall
 Subcategory: Sconce

PHYSICAL

Shape: Rectangle
 Length (mm): 200
 Length (in): 7 ⁷/₈
 Width (mm): 40
 Width (in): 1 ⁹/₁₆
 Height (mm): 120
 Height (in): 4 ³/₄
 Extension (mm): 40
 Extension (in): 1 ⁹/₁₆
 Light Distribution: Direct / Indirect
 Diffuser: Opal
 Fixture Finish: [WAL / ASH / OAK / BLK / WHI](#)
 Fixture Material: Wood

ELECTRICAL

Lamp Type: LED
 Input Wattage (W): 6
 Total Output Wattage (W): 4.5
 Dimming: Tri-Mode (Non-Dimming and Phase Dimming (120Vac only) and 0-10V Dimming)
 Driver Included: Yes
 Driver Location: Remote
 Driver Type: Constant Current - Universal
 Driver Class: Class 2
 Housing: ENCP3
 Input Voltage (V): 120 - 277
 Constant Current (MA): 500

LED

Color Temperature (°K): [2700 / 3000 / 4000](#)
 Max. Delivered Lumen (lm): 300
 CRI: >93 CRI
 Lamp Life (hrs): 50000

OPTICAL

RATINGS AND CERTIFICATIONS

Certified By: Certified for North American Standards
 IP rating: IP20

PROJECT
TYPE
SPECIFIER
QUANTITY
DATE



LED120 SURFACE

D73027-

PROJECT

TYPE

SPECIFIER

QUANTITY

DATE



D

LED120 SURFACE

D73028- -

base number Color Finish
Temperature Options

- To build a product code in our configurator select the specify button on the base model # product page
- To build a manual product code on this datasheet choose from the options listed below in blue font and add the suffix to the base model #

GENERAL

Series: Woodlin
Subseries: LED120
Brand: Tunto
Division: Design
Mounting Type: Surface
Mounting Location: Wall
Subcategory: Sconce

PHYSICAL

Shape: Rectangle
Length (mm): 400
Length (in): 15 3/4
Width (mm): 40
Width (in): 1 9/16
Height (mm): 120
Height (in): 4 3/4
Extension (mm): 40
Extension (in): 1 9/16
Light Distribution: Direct / Indirect
Diffuser: Opal
Fixture Finish: WAL / ASH / OAK / BLK / WHI
Fixture Material: Wood

ELECTRICAL

Lamp Type: LED
Input Wattage (W): 16
Total Output Wattage (W): 12.6
Dimming: Tri-Mode (Non-Dimming and Phase Dimming (120Vac only) and 0-10V Dimming)
Driver Included: Yes
Driver Location: Remote
Driver Type: Constant Current - Universal
Driver Class: Class 2
Housing: ENCP3
Input Voltage (V): 120 - 277
Constant Current (MA): 700

LED

Color Temperature (°K): 2700 / 3000 / 4000
Max. Delivered Lumen (lm): 800
CRI: >93 CRI
Lamp Life (hrs): 50000

OPTICAL

RATINGS AND CERTIFICATIONS

Certified By: Certified for North American Standards
IP rating: IP20

PROJECT
TYPE
SPECIFIER
QUANTITY
DATE

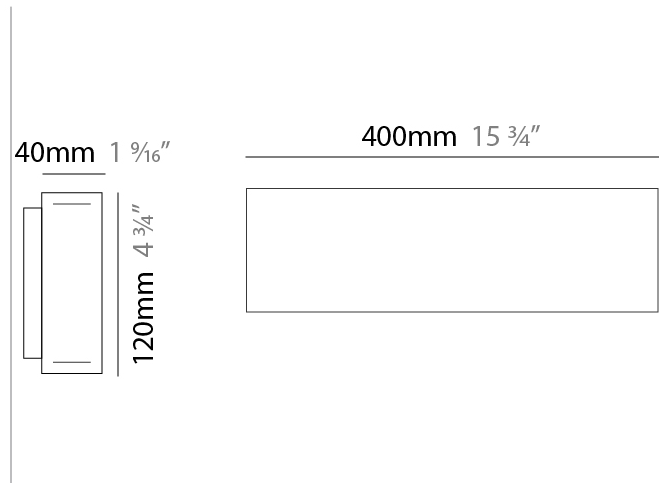

LED120 SURFACE

D73028-

PROJECT

TYPE

SPECIFIER

QUANTITY

DATE



D

LED120 SURFACE

D73029- -

base number
 Color Finish
 Temperature Options

- To build a product code in our configurator select the specify button on the base model # product page
- To build a manual product code on this datasheet choose from the options listed below in blue font and add the suffix to the base model #

GENERAL

Series: Woodlin
 Subseries: LED120
 Brand: Tunto
 Division: Design
 Mounting Type: Surface
 Mounting Location: Wall
 Subcategory: Sconce

PHYSICAL

Shape: Rectangle
 Length (mm): 700
 Length (in): 27 ⁹/₁₆
 Width (mm): 40
 Width (in): 1 ⁹/₁₆
 Height (mm): 120
 Height (in): 4 ³/₄
 Extension (mm): 40
 Extension (in): 1 ⁹/₁₆
 Light Distribution: Direct / Indirect
 Diffuser: Opal
 Fixture Finish: [WAL / ASH / OAK / BLK / WHI](#)
 Fixture Material: Wood

ELECTRICAL

Lamp Type: LED
 Input Wattage (W): 31
 Total Output Wattage (W): 25.3
 Dimming: Tri-Mode (Non-Dimming and Phase Dimming (120Vac only) and 0-10V Dimming)
 Driver Included: Yes
 Driver Location: Remote
 Driver Type: Constant Current - Universal
 Driver Class: Class 2
 Housing: ENCP3
 Input Voltage (V): 120 - 277
 Constant Current (MA): 700

LED

[Color Temperature \(°K\): 2700 / 3000 / 4000](#)
 Max. Delivered Lumen (lm): 1500
 CRI: >93 CRI
 Lamp Life (hrs): 50000

OPTICAL

RATINGS AND CERTIFICATIONS

Certified By: Certified for North American Standards
 IP rating: IP20

PROJECT
TYPE
SPECIFIER
QUANTITY
DATE

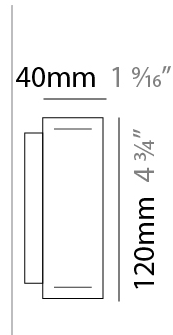

700mm 27 ⁹/₁₆"



Indirect



LED120 SURFACE

D73029-

PROJECT _____

TYPE _____

SPECIFIER _____

QUANTITY _____

DATE _____



PROJECT

TYPE

SPECIFIER

QUANTITY

DATE

Fixture Finish

Walnut Natural - WAL



Ash White Oil Waxed - ASH



Oak Natural - OAK



Black - BLK



White - WHI

Digital: Not all screens are calibrated the same, and therefore, colors will appear differently between screens.

Physical: When texture is involved, there will be variations in color, character and tone within a product series and between product families.

Wood is a living, organic material. Hence, the patterns and hues can vary, and can change as the material ages. We are not responsible for any natural material transformation and development.



PROJECT	
TYPE	
SPECIFIER	
QUANTITY	
DATE	

LEGEND

floor-mounted	pivotal	special LED (upon request) RGB, RGBW, tunable, gold+, meat+, art+, fashion+
wall and ceiling: recessed and surface mounted	rotating	warm dim / natural dimming LED
ceiling-mounted and wall-mounted	illuminate tilted	rechargeable battery powered
wall-mounted	color of suspension cable	fixture with natural vivid LED (upon request)
omni-directional light distribution	length of suspension cable	color rendering index
direct light distribution	reflector degree selection	color temperature
direct/indirect light distribution	super spot	lumen (luminous flux)
indirect light distribution	lens	efficacy (lumens per watt)
asymmetric light distribution	lens pack	Unified Glare Rating (UGR) range from 5-40
aura light distribution	shine ring	marine grade (AISI 316 stainless steel)
round wall or ceiling cut-out	integrated shine ring with diffuser	walk on
square wall or ceiling cut-out	free individual colors 01-29	drive on
the supplied jig specifies the cutout dimensions	individual colors: 00 (free of charge), 01-25 (extra charge)	Dark Sky Compliance
minimum distance (meters) lamp - object	luminaire part to be colored (F1)	Americans with Disabilities Act (less than 4" off the wall located between 27"-84" from floor)
recessed depth	luminaire part to be colored (F2)	lamp protected against explosion
ceiling thickness in mm	luminaire part to be colored (F3)	blown glass using traditional methods by master glass blower
ceiling thickness selection	luminaire part to be colored (F4)	acoustic material
dimmable DP (phase), DV (0-10V), DD (dali), DS (step-dim)	luminaire part to be colored (F5)	protection class I, protection insulation
included or excluded LED driver/transformer/control gear	color of 3-circuit adaptor	protection class II, protection insulation
separately switchable	indirect diffuser	ETL Certified to UL and CSA Standards
sensor	direct diffuser	UL Certified to UL and CSA Standards
remote control	ball-proof (upon request)	CSA Certified to UL and CSA Standards
available upon request	accessory	Certified for North American Standards

IP RATING

IP20	protected against ingress of solid bodies greater than 12.5mm (finger)
IP33	protected against ingress of solid bodies greater than 2.5mm protected against sprays of water up to 60 degrees from the vertical (rain)
IP40	protected against ingress of solid bodies greater than 1mm (wire) no protection against the ingress of moisture
IP43	protected against ingress of solid bodies greater than 1mm (wire) protected against sprays of water up to 60 degrees from the vertical (rain)
IP44	protected against ingress of solid bodies greater than 1mm (wire) protected against water splashed from all directions
IP54	protected against limited ingress of dust (wet rooms/covered outdoor areas) protected against water splashed from all directions
IP65	protected against ingress of dust protected against jets of water
IP66	protected against ingress of dust protected against powerful jets of water or heavy seas
IP67	protected against ingress of dust protected against immersion of water between 15cm - 1m for 30 minutes
IP68	protected against ingress of dust protected against immersion of water under pressure for long periods

IK RATING

IK01	protected against 0.14 joules impact (equivalent to 0.25kg mass dropped from 56mm above the surface)
IK02	protected against 0.2 joules impact (equivalent to 0.25kg mass dropped from 80mm above the surface)
IK03	protected against 0.35 joules impact (equivalent to 0.25kg mass dropped from 140mm above the surface)
IK04	protected against 0.5 joules impact (equivalent to 0.25kg mass dropped from 200mm above the surface)
IK05	protected against 0.7 joules impact (equivalent to 0.25kg mass dropped from 280mm above the surface)
IK06	protected against 1 joules impact (equivalent to 0.25kg mass dropped from 400mm above the surface)
IK07	protected against 2 joules impact (equivalent to 0.5kg mass dropped from 400mm above the surface)
IK08	protected against 5 joules impact (equivalent to 1.7kg mass dropped from 300mm above the surface)
IK09	protected against 10 joules impact (equivalent to 5.0kg mass dropped from 200mm above the surface)
IK10	protected against 20 joules impact (equivalent to 5.0kg mass dropped from 400mm above the surface)