

ZOE MONOPOINT SUSPENSION

D141121- -

base number Finish Options Finish Options

- To build a product code in our configurator select the specify button on the base model # product page
- To build a manual product code on this datasheet choose from the options listed below in blue font and add the suffix to the base model #

GENERAL

Series: Zoe
 Subseries: Zoe Monopoint
 Partner: Cangini & Tucci
 Division: Design
 Installation: Suspension
 Product Type: Pendant
 Mounting Location: Ceiling

PHYSICAL

Shape: Teardrop
 Diameter (mm): 160
 Diameter (in): 6 ⁵/₁₆
 Height (mm): 280
 Height (in): 11
 Max. Overall Height (mm): 1780
 Max. Overall Height (in): 70 ⁷/₁₆
 Weight (kg): 0.79
 Weight (lbs): 1.74
 Diffuser: Glass - Opal
 Fixture Finish: [AMB](#) / [BLK](#) / [BRZ](#) / [GLD](#) / [GRN](#) / [PNK](#) / [RUB](#) / [SKB](#) / [SMK](#) / [TOB](#) / [TRA](#)
 Holder Finish: CHR / MWH / MBK / BCR
 Fixture Material: Glass / Metal
 Primary Material: Glass - Borosilicate
 Cable Details: 1500mm cable

ELECTRICAL

Number of Lamps: 1
 Lamp Type: LED Retrofit
 Bulb Included: Bulb Not Included
 Max. Wattage Per Lamp (W): 5
 Lamp Base: G9
 Input Voltage (V): 120

LED

OPTICAL

RATINGS AND CERTIFICATIONS

Certified By: Certified for North American Standards
 IP rating: IP20

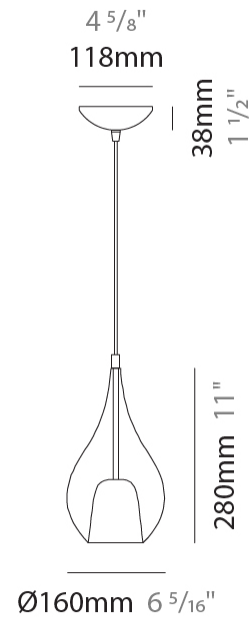

ZOE MONOPOINT SUSPENSION

D141121-

PROJECT _____

TYPE _____

SPECIFIER _____

QUANTITY _____

DATE _____

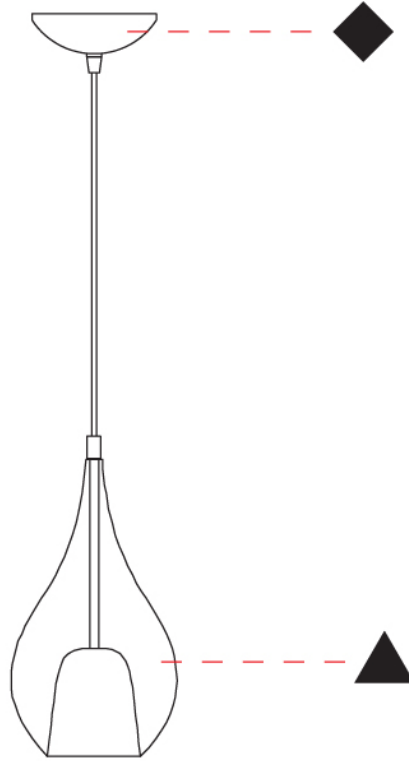

D

ZOE MONOPOINT SUSPENSION

D141122-

base number Finish Options - Finish Options

- To build a product code in our configurator select the specify button on the base model # product page
- To build a manual product code on this datasheet choose from the options listed below in blue font and add the suffix to the base model #

GENERAL

Series: Zoe
 Subseries: Zoe Monopoint
 Partner: Cangini & Tucci
 Division: Design
 Installation: Suspension
 Product Type: Pendant
 Mounting Location: Ceiling

PHYSICAL

Shape: Teardrop
 Diameter (mm): 220
 Diameter (in): 8 ¹¹/₁₆
 Height (mm): 380
 Height (in): 14 ¹⁵/₁₆
 Max. Overall Height (mm): 1880
 Max. Overall Height (in): 74
 Weight (kg): 1.51
 Weight (lbs): 3.33
 Diffuser: Glass - Opal
 Fixture Finish: [AMB](#) / [BLK](#) / [BRZ](#) / [GLD](#) / [GRN](#) / [PNK](#) / [RUB](#) / [SKB](#) / [SMK](#) / [TOB](#) / [TRA](#)
 Holder Finish: [CHR](#) / [MWH](#) / [MBK](#) / [BCR](#)
 Fixture Material: Glass / Metal
 Primary Material: Glass - Borosilicate
 Cable Details: 1500mm cable

ELECTRICAL

Number of Lamps: 1
 Lamp Type: LED Retrofit
 Lamp Shape: A19
 Bulb Included: Bulb Not Included
 Max. Wattage Per Lamp (W): 16
 Lamp Base: E26
 Input Voltage (V): 120
 Upon Request: 277Vac / GU24

LED

OPTICAL

RATINGS AND CERTIFICATIONS

Certified By: Certified for North American Standards
 IP rating: IP20

PROJECT
TYPE
SPECIFIER
QUANTITY
DATE

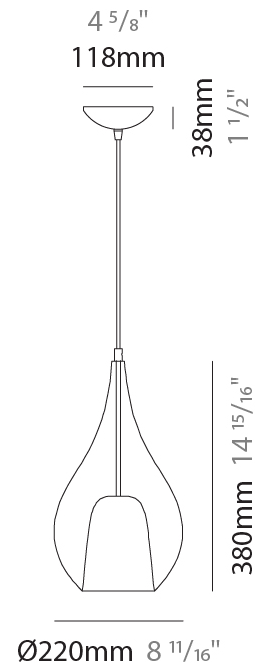

ZOE MONOPOINT SUSPENSION

D141122-

PROJECT	_____
TYPE	_____
SPECIFIER	_____
QUANTITY	_____
DATE	_____

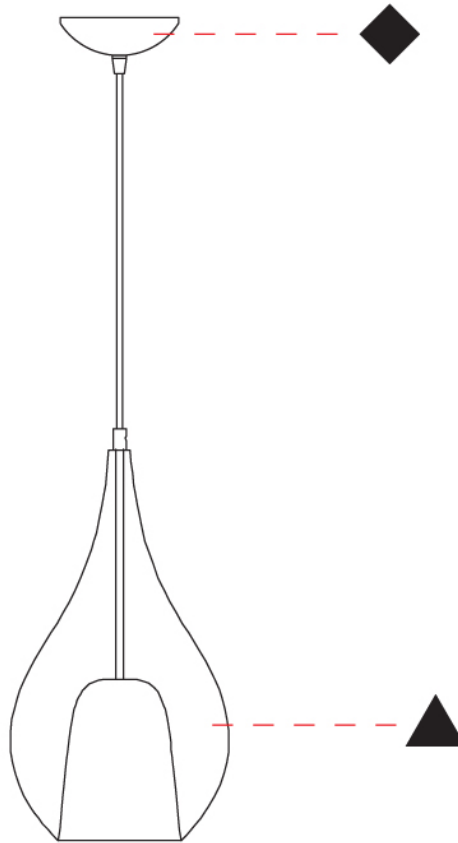

D

PROJECT	_____
TYPE	_____
SPECIFIER	_____
QUANTITY	_____
DATE	_____

ZOE MONOPOINT SUSPENSION

D141123-

base number Finish Options - Finish Options

- To build a product code in our configurator select the specify button on the base model # product page
- To build a manual product code on this datasheet choose from the options listed below in blue font and add the suffix to the base model #

GENERAL

Series: Zoe
 Subseries: Zoe Monopoint
 Partner: Cangini & Tucci
 Division: Design
 Installation: Suspension
 Product Type: Pendant
 Mounting Location: Ceiling

PHYSICAL

Shape: Teardrop
 Diameter (mm): 300
 Diameter (in): 11 ¹³/₁₆
 Height (mm): 530
 Height (in): 20 ⁷/₈
 Max. Overall Height (mm): 2030
 Max. Overall Height (in): 79 ¹⁵/₁₆
 Weight (kg): 2.50
 Weight (lbs): 5.51
 Diffuser: Glass - Opal
 Fixture Finish: [AMB / BLK / BRZ / GLD / GRN / PNK / RUB / SKB / SMK / TOB / TRA](#)
 Holder Finish: CHR / MWH / MBK / BCR
 Fixture Material: Glass / Metal
 Primary Material: Glass - Borosilicate
 Cable Details: 1500mm Cable

ELECTRICAL

Number of Lamps: 1
 Lamp Type: LED Retrofit
 Lamp Shape: A19
 Bulb Included: Bulb Not Included
 Max. Wattage Per Lamp (W): 16
 Lamp Base: E26
 Input Voltage (V): 120
 Upon Request: 277Vac / GU24

LED

OPTICAL

RATINGS AND CERTIFICATIONS

Certified By: Certified for North American Standards
 IP rating: IP20

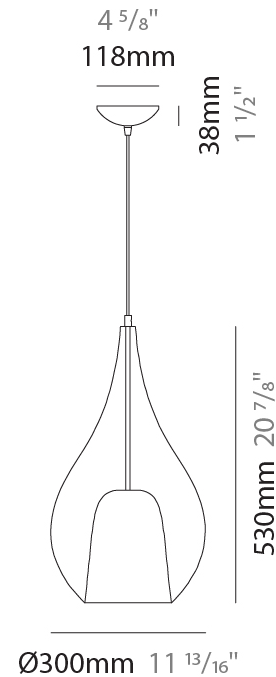

ZOE MONOPOINT SUSPENSION

D141123-

PROJECT _____

TYPE _____

SPECIFIER _____

QUANTITY _____

DATE _____

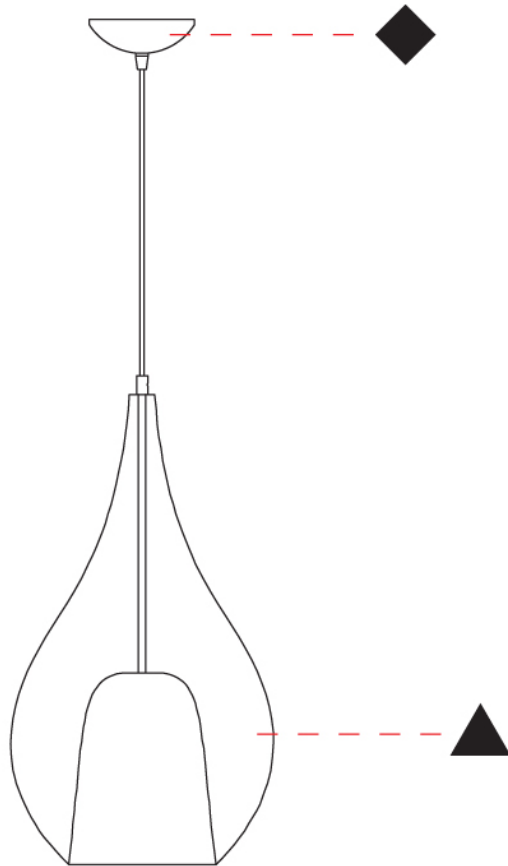

D

ZOE 2 LIGHT SWAG SUSPENSION

D141127-

base number Finish Options - Finish Options

- To build a product code in our configurator select the specify button on the base model # product page
- To build a manual product code on this datasheet choose from the options listed below in blue font and add the suffix to the base model #

GENERAL

Series: Zoe
 Subseries: Zoe 2 Light Swag
 Partner: Cangini & Tucci
 Division: Design
 Installation: Suspension
 Product Type: Pendant
 Mounting Location: Ceiling

PHYSICAL

Shape: Teardrop
 Diameter (mm): 160
 Diameter (in): 6 ⁵/₁₆
 Height (mm): 280
 Height (in): 11
 Max. Overall Height (mm): 2280
 Max. Overall Height (in): 89 ³/₄
 Weight (kg): 1.53
 Weight (lbs): 3.37
 Diffuser: Glass - Opal
 Fixture Finish: [AMB / BLK / BRZ / GLD / GRN / PNK / RUB / SKB / SMK / TOB / TRA](#)
 Holder Finish: CHR / MWH / MBK / BCR
 Fixture Material: Glass / Metal
 Primary Material: Glass - Borosilicate
 Cable Details: 2000mm cable

ELECTRICAL

Number of Lamps: 2
 Lamp Type: LED Retrofit
 Bulb Included: Bulb Not Included
 Total Output Wattage (W): 10
 Max. Wattage Per Lamp (W): 5
 Lamp Base: G9
 Input Voltage (V): 120

LED

OPTICAL

RATINGS AND CERTIFICATIONS

Certified By: Certified for North American Standards
 IP rating: IP20

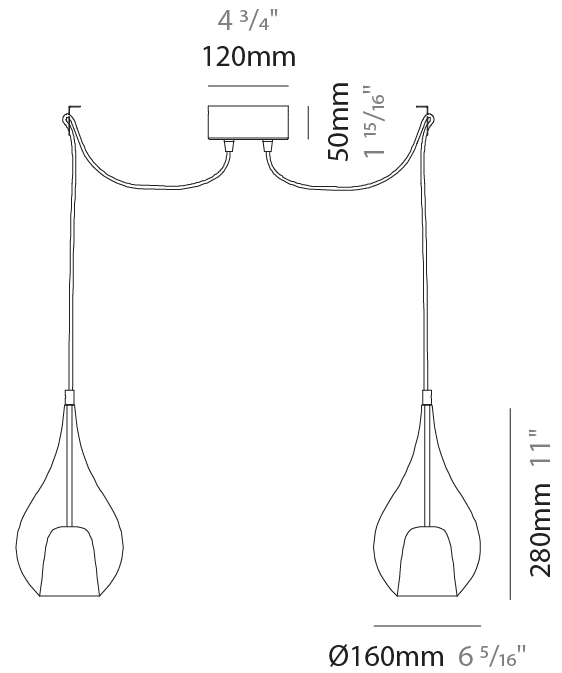

ZOE 2 LIGHT SWAG SUSPENSION

D141127-

PROJECT	_____
TYPE	_____
SPECIFIER	_____
QUANTITY	_____
DATE	_____

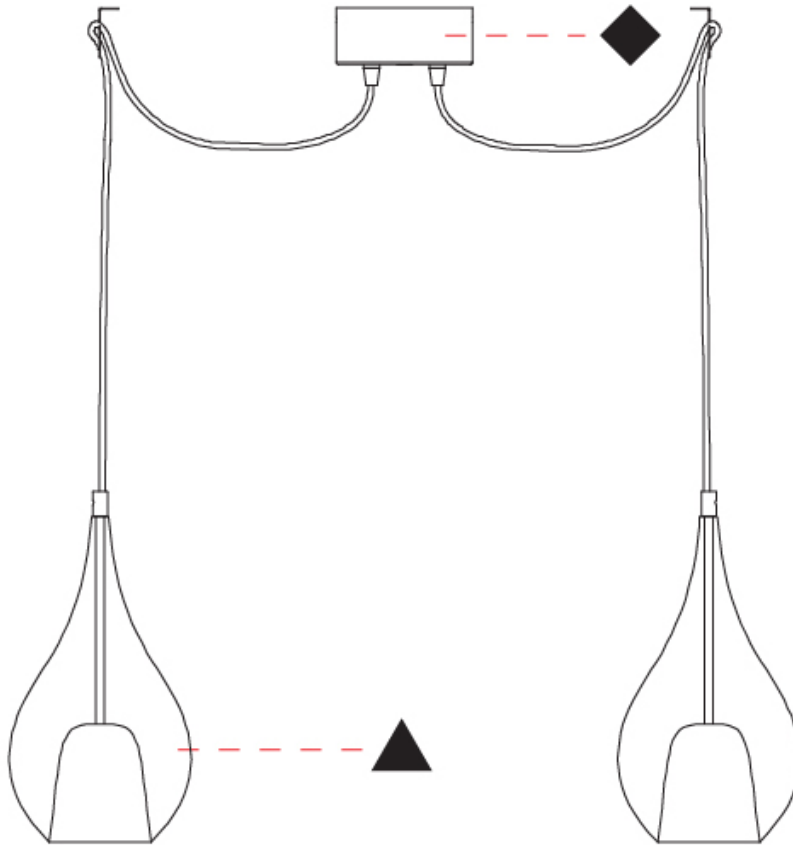

D

ZOE 3 LIGHT SWAG SUSPENSION

D141128-

base number Finish Finish
 Options Options

- To build a product code in our configurator select the specify button on the base model # product page
- To build a manual product code on this datasheet choose from the options listed below in blue font and add the suffix to the base model #

GENERAL

Series: Zoe
 Subseries: Zoe 3 Light Swag
 Partner: Cangini & Tucci
 Division: Design
 Installation: Suspension
 Product Type: Pendant
 Mounting Location: Ceiling

PHYSICAL

Shape: Teardrop
 Diameter (mm): 160
 Diameter (in): 6 ⁵/₁₆
 Height (mm): 280
 Height (in): 11
 Max. Overall Height (mm): 2280
 Max. Overall Height (in): 89 ³/₄
 Weight (kg): 2.25
 Weight (lbs): 4.96
 Diffuser: Glass - Opal
 Fixture Finish: [AMB / BLK / BRZ / GLD / GRN / PNK / RUB / SKB / SMK / TOB / TRA](#)
 Holder Finish: CHR / MWH / MBK / BCR
 Fixture Material: Glass / Metal
 Primary Material: Glass - Borosilicate
 Cable Details: 2000mm cable

ELECTRICAL

Number of Lamps: 3
 Lamp Type: LED Retrofit
 Bulb Included: Bulb Not Included
 Total Output Wattage (W): 15
 Max. Wattage Per Lamp (W): 5
 Lamp Base: G9
 Input Voltage (V): 120

LED

OPTICAL

RATINGS AND CERTIFICATIONS

Certified By: Certified for North American Standards
 IP rating: IP20

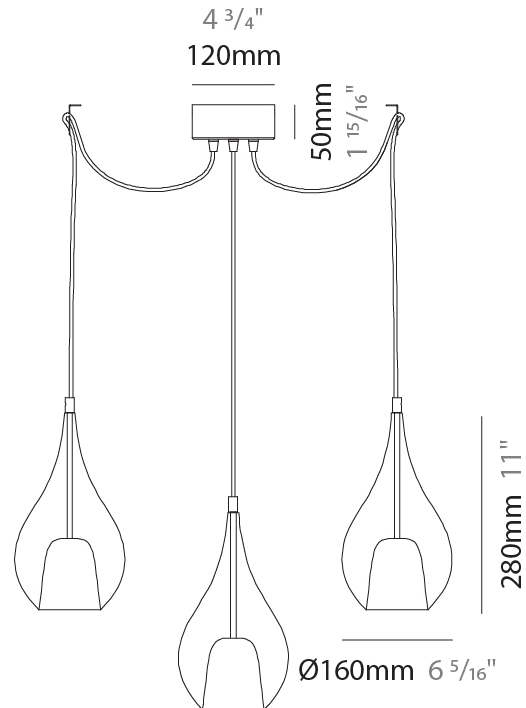

ZOE 3 LIGHT SWAG SUSPENSION

D141128-

PROJECT	_____
TYPE	_____
SPECIFIER	_____
QUANTITY	_____
DATE	_____

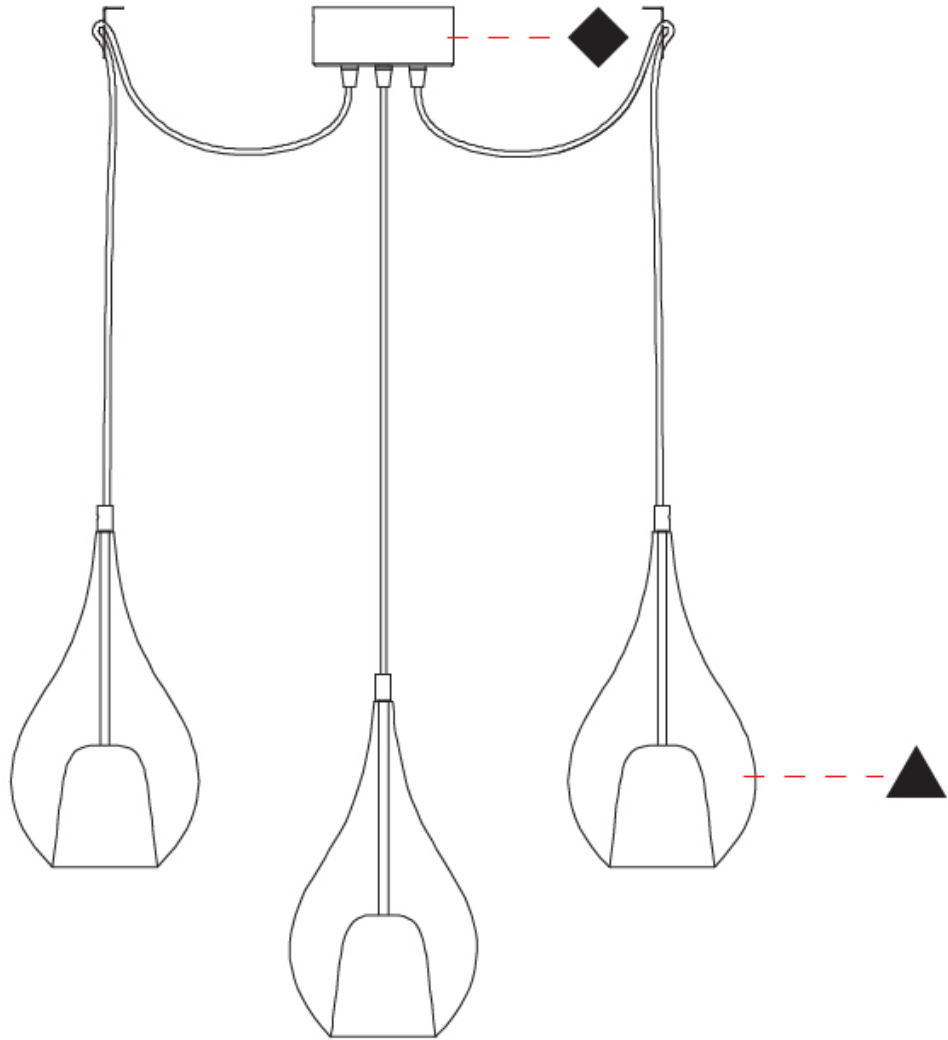

D

PROJECT	_____
TYPE	_____
SPECIFIER	_____
QUANTITY	_____
DATE	_____

ZOE 2 LIGHT SWAG SUSPENSION

D141129-

base number	Finish Options	Finish Options
-------------	----------------	----------------

- To build a product code in our configurator select the specify button on the base model # product page
- To build a manual product code on this datasheet choose from the options listed below in blue font and add the suffix to the base model #

GENERAL

Series: Zoe
Subseries: Zoe 2 Light Swag
Partner: Cangini & Tucci
Division: Design
Installation: Suspension
Product Type: Pendant
Mounting Location: Ceiling

PHYSICAL

Shape: Teardrop
Diameter (mm): 220
Diameter (in): 8 ¹¹ / ₁₆
Height (mm): 380
Height (in): 14 ¹⁵ / ₁₆
Max. Overall Height (mm): 2380
Max. Overall Height (in): 93 ¹¹ / ₁₆
Weight (kg): 2.81
Weight (lbs): 6.19
Diffuser: Glass - Opal
Fixture Finish: AMB / BLK / BRZ / GLD / GRN / PNK / RUB / SKB / SMK / TOB / TRA
Holder Finish: CHR / MWH / MBK / BCR
Fixture Material: Glass / Metal
Primary Material: Glass - Borosilicate
Cable Details: 2000mm cable

ELECTRICAL

Number of Lamps: 2
Lamp Type: LED Retrofit
Lamp Shape: A19
Bulb Included: Bulb Not Included
Total Output Wattage (W): 32
Max. Wattage Per Lamp (W): 16
Lamp Base: E26
Input Voltage (V): 120
Upon Request: 277Vac / GU24

LED

OPTICAL

RATINGS AND CERTIFICATIONS

Certified By: Certified for North American Standards
IP rating: IP20

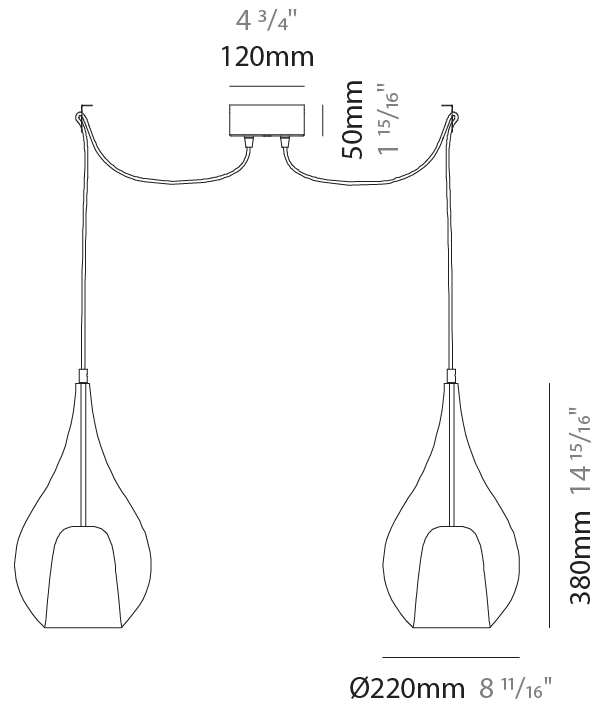

ZOE 2 LIGHT SWAG SUSPENSION

D141129-

PROJECT	_____
TYPE	_____
SPECIFIER	_____
QUANTITY	_____
DATE	_____

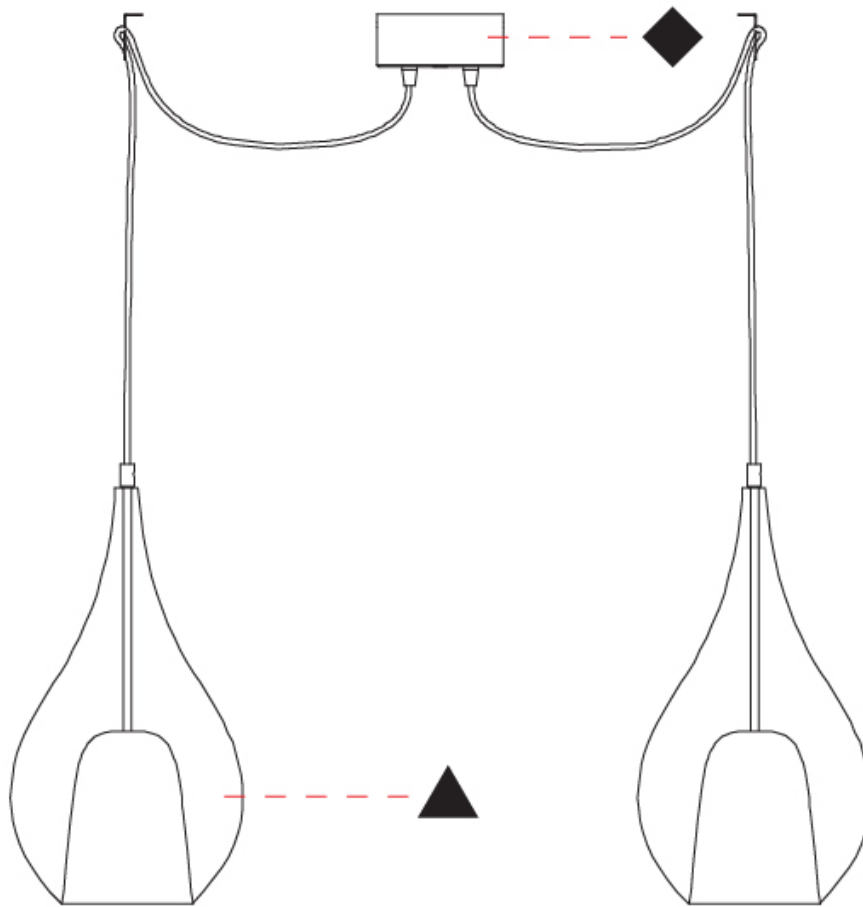

D

PROJECT	
TYPE	
SPECIFIER	
QUANTITY	
DATE	

ZOE 2 LIGHT SWAG SUSPENSION

D141130-

base number Finish Options Finish Options

- To build a product code in our configurator select the specify button on the base model # product page
- To build a manual product code on this datasheet choose from the options listed below in blue font and add the suffix to the base model #

GENERAL

Series: Zoe
 Subseries: Zoe 2 Light Swag
 Partner: Cangini & Tucci
 Division: Design
 Installation: Suspension
 Product Type: Pendant
 Mounting Location: Ceiling

PHYSICAL

Shape: Teardrop
 Diameter (mm): 300
 Diameter (in): 11 ¹³/₁₆
 Height (mm): 530
 Height (in): 20 ⁷/₈
 Max. Overall Height (mm): 2530
 Max. Overall Height (in): 99 ⁵/₈
 Weight (kg): 4.8
 Weight (lbs): 10.58
 Diffuser: Glass - Opal
 Fixture Finish: [AMB / BLK / BRZ / GLD / GRN / PNK / RUB / SKB / SMK / TOB / TRA](#)
 Holder Finish: CHR / MWH / MBK / BCR
 Fixture Material: Glass / Metal
 Primary Material: Glass - Borosilicate
 Cable Details: 2000mm cable

ELECTRICAL

Number of Lamps: 2
 Lamp Type: LED Retrofit
 Lamp Shape: A19
 Bulb Included: Bulb Not Included
 Total Output Wattage (W): 32
 Max. Wattage Per Lamp (W): 16
 Lamp Base: E26
 Input Voltage (V): 120
 Upon Request: 277Vac / GU24

LED

OPTICAL

RATINGS AND CERTIFICATIONS

Certified By: Certified for North American Standards
 IP rating: IP20

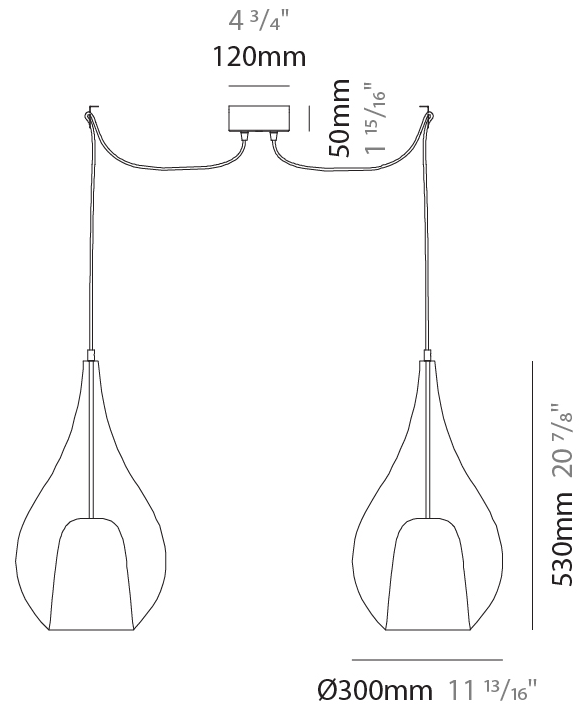

ZOE 2 LIGHT SWAG SUSPENSION

D141130-

PROJECT _____

TYPE _____

SPECIFIER _____

QUANTITY _____

DATE _____

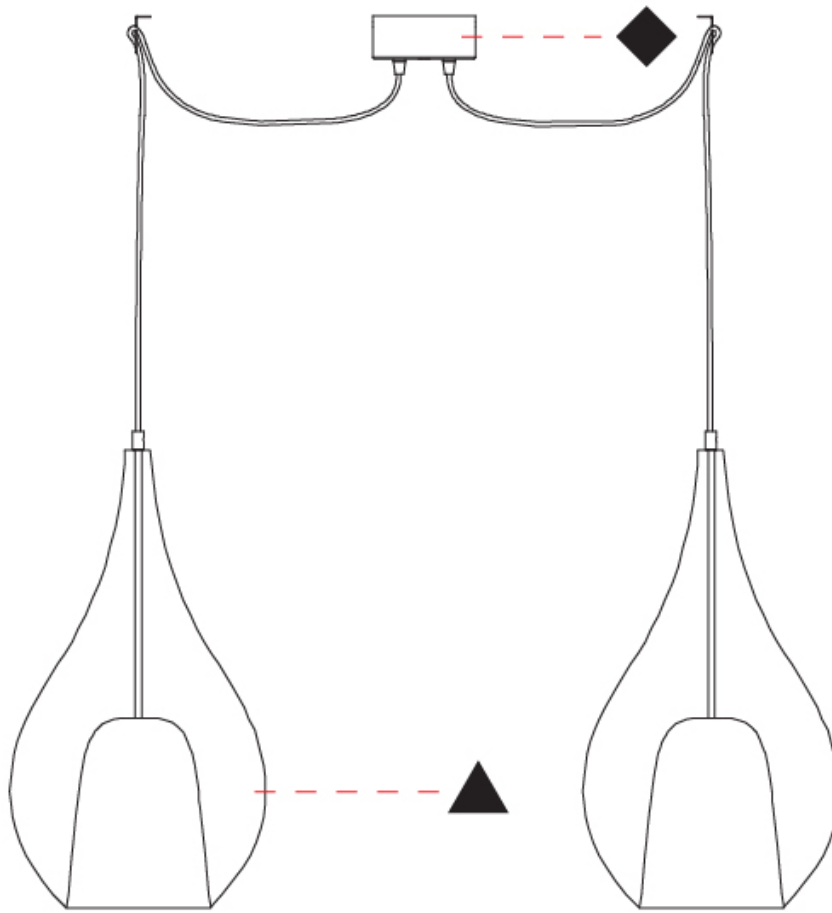

D

PROJECT
TYPE
SPECIFIER
QUANTITY
DATE

ZOE 3 LIGHT LINEAR SUSPENSION

D141131- -
 base number Finish Finish
 Options Options

- To build a product code in our configurator select the specify button on the base model # product page
- To build a manual product code on this datasheet choose from the options listed below in blue font and add the suffix to the base model #

GENERAL

Series: Zoe
 Subseries: Zoe 3 Light Linear
 Partner: Cangini & Tucci
 Division: Design
 Installation: Suspension
 Product Type: Pendant
 Mounting Location: Ceiling

PHYSICAL

Shape: Teardrop
 Length (mm): 1000
 Length (in): 39 ³/₈
 Height (mm): 280
 Height (in): 11
 Max. Overall Height (mm): 1780
 Max. Overall Height (in): 70 ⁷/₁₆
 Weight (kg): 2.90
 Weight (lbs): 6.39
 Diffuser: Glass - Opal
 Fixture Finish: [AMB](#) / [BLK](#) / [BRZ](#) / [GLD](#) / [GRN](#) / [PNK](#) / [RUB](#) / [SKB](#) / [SMK](#) / [TOB](#) / [TRA](#)
 Holder Finish: [CHR](#) / [MWH](#) / [MBK](#) / [BCR](#)
 Fixture Material: Glass / Metal
 Primary Material: Glass - Borosilicate
 Cable Details: 1500mm cable

ELECTRICAL

Number of Lamps: 3
 Lamp Type: LED Retrofit
 Bulb Included: Bulb Not Included
 Total Output Wattage (W): 15
 Max. Wattage Per Lamp (W): 5
 Lamp Base: G9
 Input Voltage (V): 120

LED

OPTICAL

RATINGS AND CERTIFICATIONS

Certified By: Certified for North American Standards
 IP rating: IP20

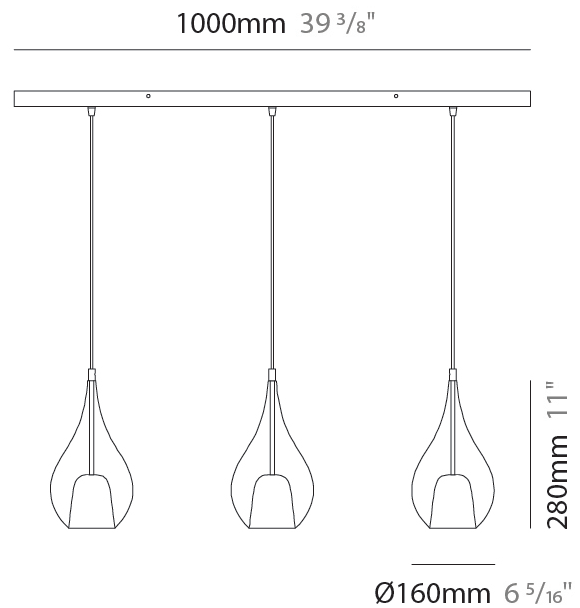

ZOE 3 LIGHT LINEAR SUSPENSION

D141131-

PROJECT	_____
TYPE	_____
SPECIFIER	_____
QUANTITY	_____
DATE	_____

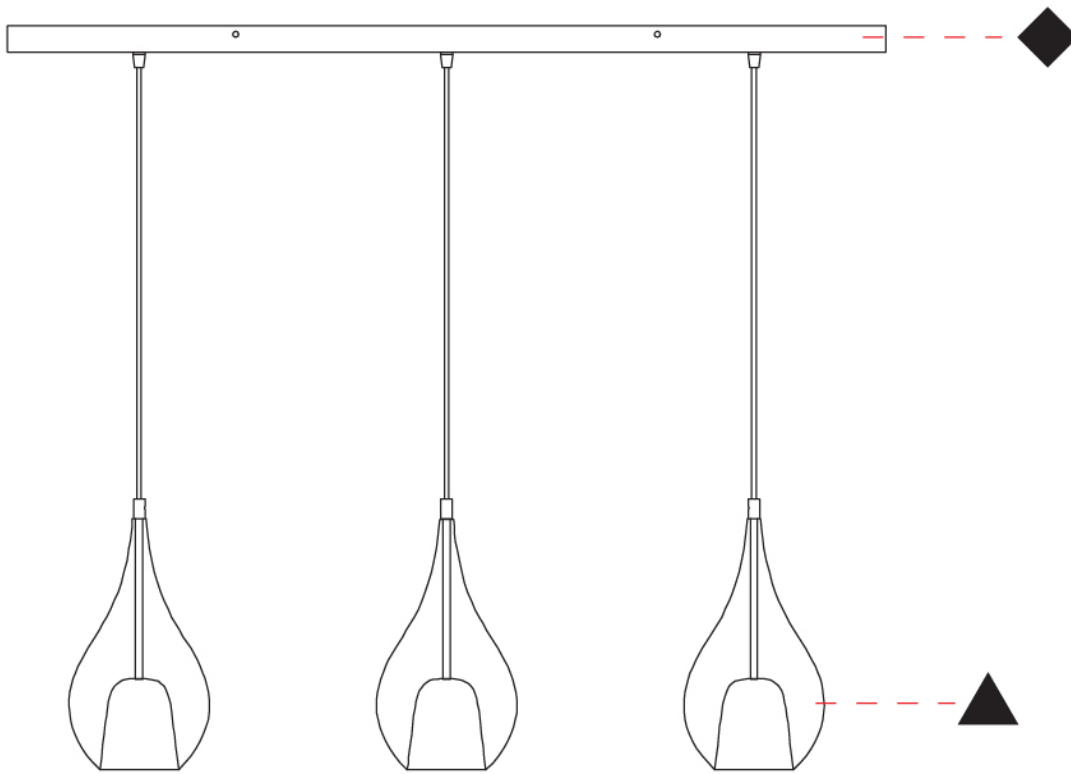

D

PROJECT
TYPE
SPECIFIER
QUANTITY
DATE

ZOE 3 LIGHT LINEAR SUSPENSION

D141132-

base number Finish Finish
Options Options

- To build a product code in our configurator select the specify button on the base model # product page
- To build a manual product code on this datasheet choose from the options listed below in blue font and add the suffix to the base model #

GENERAL

Series: Zoe
 Subseries: Zoe 3 Light Linear
 Partner: Cangini & Tucci
 Division: Design
 Installation: Suspension
 Product Type: Pendant
 Mounting Location: Ceiling

PHYSICAL

Shape: Teardrop
 Length (mm): 1200
 Length (in): 47 1/4
 Height (mm): 280
 Height (in): 11
 Max. Overall Height (mm): 1780
 Max. Overall Height (in): 70 7/16
 Weight (kg): 5.59
 Weight (lbs): 12.32
 Diffuser: Glass - Opal
 Fixture Finish: [AMB](#) / [BLK](#) / [BRZ](#) / [GLD](#) / [GRN](#) / [PNK](#) / [RUB](#) / [SKB](#) / [SMK](#) / [TOB](#) / [TRA](#)
 Holder Finish: [CHR](#) / [MWH](#) / [MBK](#) / [BCR](#)
 Fixture Material: Glass / Metal
 Primary Material: Glass - Borosilicate
 Cable Details: 1500mm cable

ELECTRICAL

Number of Lamps: 3
 Lamp Type: LED Retrofit
 Lamp Shape: A19
 Bulb Included: Bulb Not Included
 Total Output Wattage (W): 48
 Max. Wattage Per Lamp (W): 16
 Lamp Base: E26
 Input Voltage (V): 120
 Upon Request: 277Vac / GU24

LED

OPTICAL

RATINGS AND CERTIFICATIONS

Certified By: Certified for North American Standards
 IP rating: IP20

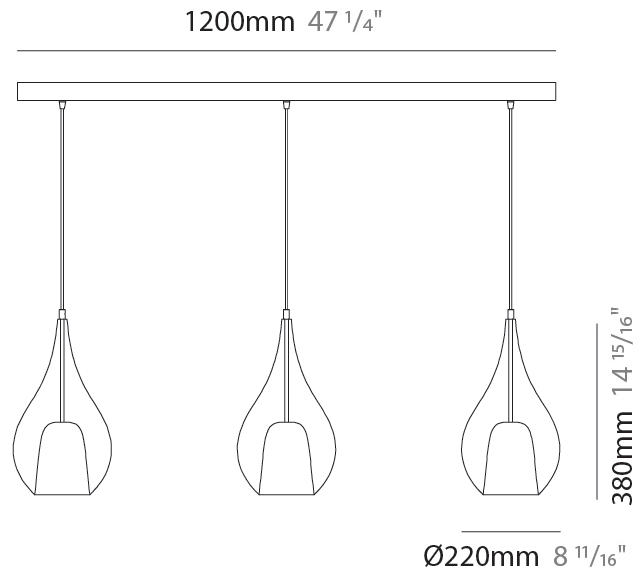

ZOE 3 LIGHT LINEAR SUSPENSION

D141132-

PROJECT	_____
TYPE	_____
SPECIFIER	_____
QUANTITY	_____
DATE	_____

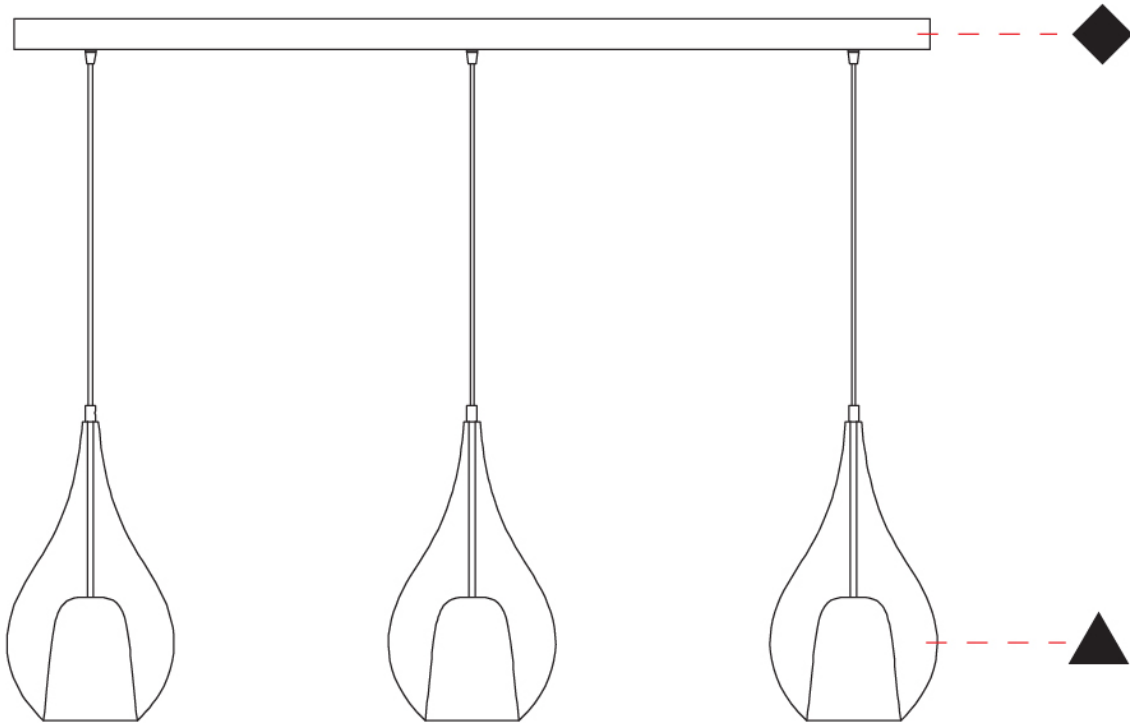

D

PROJECT	_____
TYPE	_____
SPECIFIER	_____
QUANTITY	_____
DATE	_____

ZOE 3 LIGHT CLUSTER SUSPENSION

D141133-

base number	Finish	Finish
	Options	Options

- To build a product code in our configurator select the specify button on the base model # product page
- To build a manual product code on this datasheet choose from the options listed below in blue font and add the suffix to the base model #

GENERAL

Series: Zoe
Subseries: Zoe 3 Light Cluster
Partner: Cangini & Tucci
Division: Design
Installation: Suspension
Product Type: Pendant
Mounting Location: Ceiling

PHYSICAL

Shape: Teardrop
Diameter (mm): 430
Diameter (in): 16 ¹⁵ / ₁₆
Height (mm): 1500
Height (in): 59 ¹⁵ / ₁₆
Weight (kg): 6.48
Weight (lbs): 14.29
Diffuser: Glass - Opal
Fixture Finish: AMB / BLK / BRZ / GLD / GRN / PNK / RUB / SKB / SMK / TOB / TRA
Holder Finish: CHR / MWH / MBK / BCR
Fixture Material: Glass / Metal
Primary Material: Glass - Borosilicate
Cable Details: 1500mm cable

ELECTRICAL

Number of Lamps: 3
Lamp Type: LED Retrofit
Bulb Included: Bulb Not Included
Total Output Wattage (W): 37
Max. Wattage Per Lamp (W): 16 + 5
Lamp Base: E26 + G9
Input Voltage (V): 120

LED

OPTICAL

RATINGS AND CERTIFICATIONS

Certified By: Certified for North American Standards
IP rating: IP20

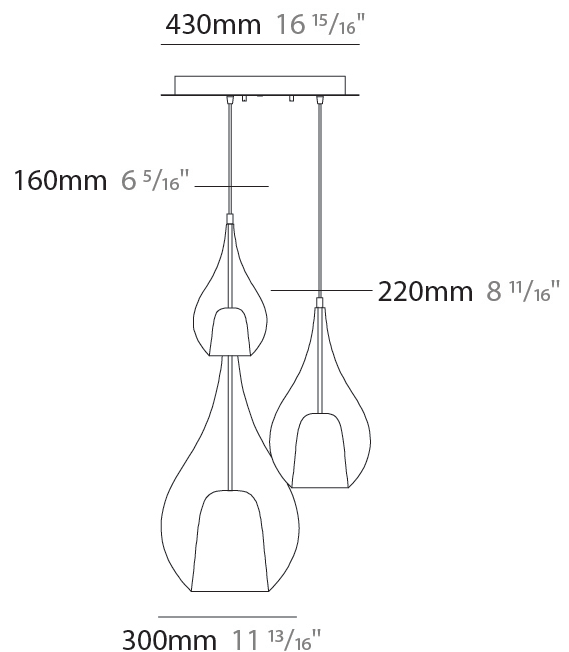

ZOE 3 LIGHT CLUSTER SUSPENSION

D141133-

PROJECT _____

TYPE _____

SPECIFIER _____

QUANTITY _____

DATE _____

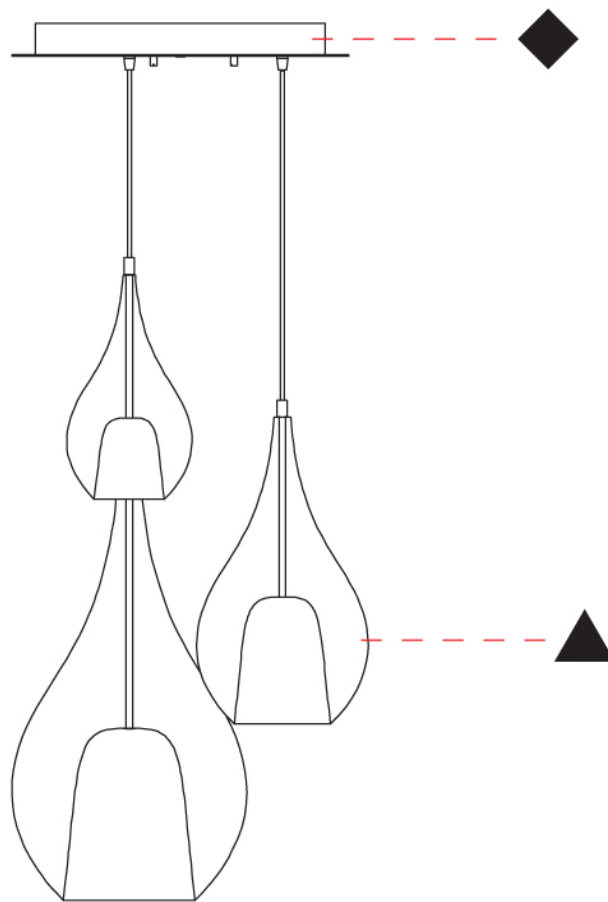

D

ZOE VINCENT - MONOPOINT SUSPENSION

D141177-

base number Finish
Options

- To build a product code in our configurator select the specify button on the base model # product page
- To build a manual product code on this datasheet choose from the options listed below in blue font and add the suffix to the base model #

GENERAL

Series: Zoe
Subseries: Zoe Vincent - Monopoint
Partner: Cangini & Tucci
Division: Design
Installation: Suspension
Product Type: Pendant
Mounting Location: Ceiling

PHYSICAL

Shape: Teardrop
Diameter (mm): 160
Diameter (in): 6 ⁵/₁₆
Height (mm): 280
Height (in): 11
Max. Overall Height (mm): 1780
Max. Overall Height (in): 70 ⁷/₁₆
Weight (kg): 0.79
Weight (lbs): 1.74
Diffuser: Glass - Opal
Fixture Finish: [MSB / MBS / TRS](#)
Holder Finish: BLK
Fixture Material: Glass / Metal
Primary Material: Glass - Borosilicate
Cable Details: 1500mm cable

ELECTRICAL

Number of Lamps: 1
Lamp Type: LED Retrofit
Bulb Included: Bulb Not Included
Max. Wattage Per Lamp (W): 5
Lamp Base: G9
Input Voltage (V): 120

LED

OPTICAL

RATINGS AND CERTIFICATIONS

Certified By: Certified for North American Standards
IP rating: IP20

PROJECT	_____
TYPE	_____
SPECIFIER	_____
QUANTITY	_____
DATE	_____

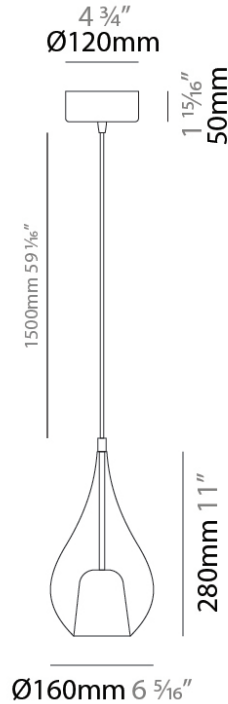

ZOE VINCENT - MONOPOINT SUSPENSION

D141177-

PROJECT

TYPE

SPECIFIER

QUANTITY

DATE

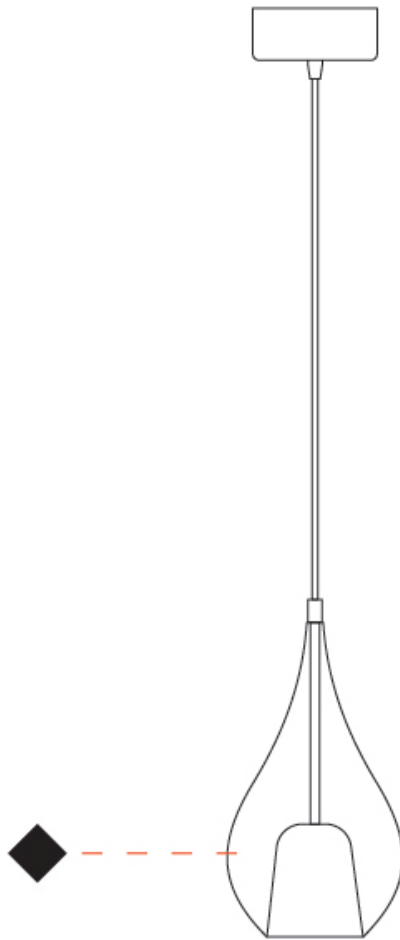

D

ZOE VINCENT - MONOPOINT SUSPENSION

D141178-

base number Finish
Options

- To build a product code in our configurator select the specify button on the base model # product page
- To build a manual product code on this datasheet choose from the options listed below in blue font and add the suffix to the base model #

GENERAL

Series: Zoe
Subseries: Zoe Vincent - Monopoint
Partner: Cangini & Tucci
Division: Design
Installation: Suspension
Product Type: Pendant
Mounting Location: Ceiling

PHYSICAL

Shape: Teardrop
Diameter (mm): 220
Diameter (in): 8 ¹¹/₁₆
Height (mm): 380
Height (in): 14 ¹⁵/₁₆
Max. Overall Height (mm): 1880
Max. Overall Height (in): 74
Weight (kg): 1.51
Weight (lbs): 3.33
Diffuser: Glass - Opal
Fixture Finish: MSB / MBS / TRS
Holder Finish: BLK
Fixture Material: Glass / Metal
Primary Material: Glass - Borosilicate
Cable Details: 1500mm cable

ELECTRICAL

Number of Lamps: 1
Lamp Type: LED Retrofit
Lamp Shape: A19
Bulb Included: Bulb Not Included
Max. Wattage Per Lamp (W): 16
Lamp Base: E26
Input Voltage (V): 120
Upon Request: 277Vac / GU24

LED

OPTICAL

RATINGS AND CERTIFICATIONS

Certified By: Certified for North American Standards
IP rating: IP20

PROJECT	_____
TYPE	_____
SPECIFIER	_____
QUANTITY	_____
DATE	_____

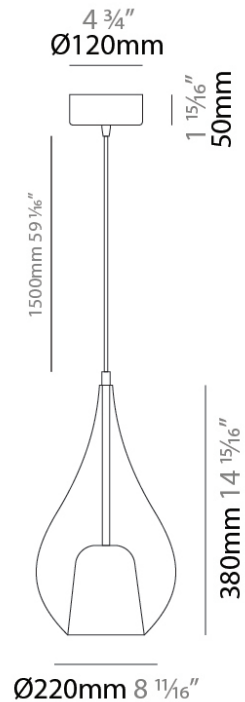

ZOE VINCENT - MONOPOINT SUSPENSION

D141178-

PROJECT

TYPE

SPECIFIER

QUANTITY

DATE

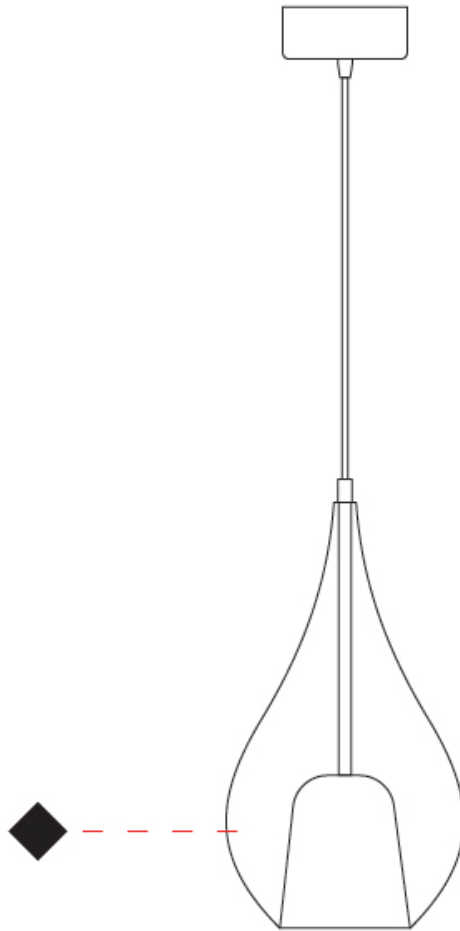

D

ZOE VINCENT - MONOPOINT SUSPENSION

D141179-

base number Finish
Options

PROJECT	_____
TYPE	_____
SPECIFIER	_____
QUANTITY	_____
DATE	_____

- To build a product code in our configurator select the specify button on the base model # product page
- To build a manual product code on this datasheet choose from the options listed below in blue font and add the suffix to the base model #

GENERAL

Series: Zoe _____
 Subseries: Zoe Vincent - Monopoint _____
 Partner: Cangani & Tucci _____
 Division: Design _____
 Installation: Suspension _____
 Product Type: Pendant _____
 Mounting Location: Ceiling _____

PHYSICAL

Shape: Teardrop _____
 Diameter (mm): 300 _____
 Diameter (in): 11 ¹³/₁₆ _____
 Height (mm): 530 _____
 Height (in): 20 ⁷/₈ _____
 Max. Overall Height (mm): 2030 _____
 Max. Overall Height (in): 79 ¹⁵/₁₆ _____
 Weight (kg): 2.50 _____
 Weight (lbs): 5.51 _____
 Diffuser: Glass - Opal _____
 Fixture Finish: [MSB](#) / [MBS](#) / [TRS](#) _____
 Holder Finish: BLK _____
 Fixture Material: Glass / Metal _____
 Primary Material: Glass - Borosilicate _____
 Cable Details: 1500mm Cable _____

ELECTRICAL

Number of Lamps: 1 _____
 Lamp Type: LED Retrofit _____
 Lamp Shape: A19 _____
 Bulb Included: Bulb Not Included _____
 Max. Wattage Per Lamp (W): 16 _____
 Lamp Base: E26 _____
 Input Voltage (V): 120 _____
 Upon Request: 277Vac / GU24 _____

LED

OPTICAL

RATINGS AND CERTIFICATIONS

Certified By: Certified for North American Standards _____
 IP rating: IP20 _____

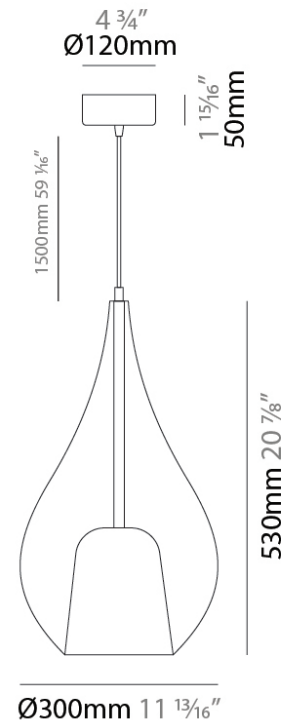

ZOE VINCENT - MONOPOINT SUSPENSION

D141179-

PROJECT

TYPE

SPECIFIER

QUANTITY

DATE

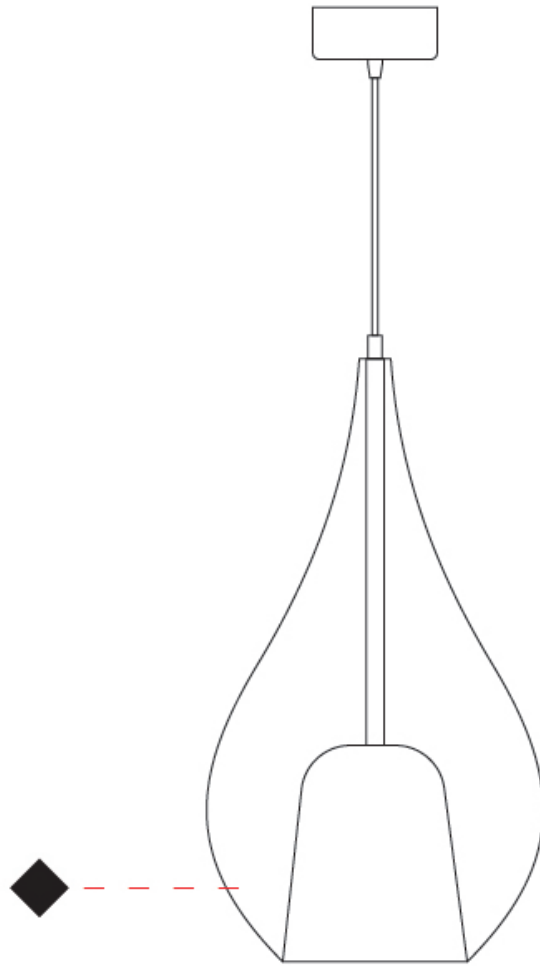

D

PROJECT	_____
TYPE	_____
SPECIFIER	_____
QUANTITY	_____
DATE	_____

ZOE VINCENT 3 LIGHT LINEAR SUSPENSION

D141249-

base number Finish
Options

- To build a product code in our configurator select the specify button on the base model # product page
- To build a manual product code on this datasheet choose from the options listed below in blue font and add the suffix to the base model #

GENERAL

Series: Zoe
 Subseries: Zoe Vincent 3 Light Linear
 Partner: Cangini & Tucci
 Division: Design
 Installation: Suspension
 Product Type: Pendant
 Mounting Location: Ceiling

PHYSICAL

Shape: Teardrop
 Length (mm): 1000
 Length (in): 39 ³/₈
 Height (mm): 280
 Height (in): 11
 Max. Overall Height (mm): 1780
 Max. Overall Height (in): 70 ⁷/₁₆
 Weight (kg): 2.90
 Weight (lbs): 6.39
 Diffuser: Glass - Opal
 Fixture Finish: [MSB / MBS / TRS](#)
 Holder Finish: BLK
 Fixture Material: Glass / Metal
 Primary Material: Glass - Borosilicate
 Cable Details: 1500mm cable

ELECTRICAL

Number of Lamps: 3
 Lamp Type: LED Retrofit
 Bulb Included: Bulb Not Included
 Total Output Wattage (W): 15
 Max. Wattage Per Lamp (W): 5
 Lamp Base: G9
 Input Voltage (V): 120

LED

OPTICAL

RATINGS AND CERTIFICATIONS

Certified By: Certified for North American Standards
 IP rating: IP20

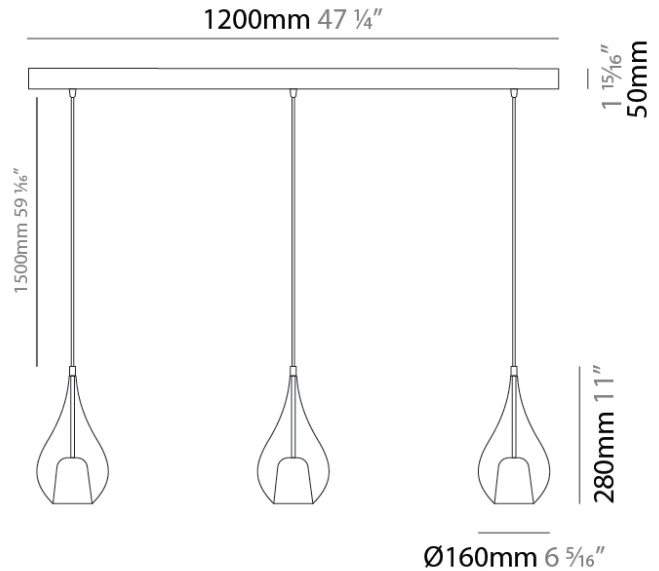

ZOE VINCENT 3 LIGHT LINEAR SUSPENSION

D141249-

PROJECT	_____
TYPE	_____
SPECIFIER	_____
QUANTITY	_____
DATE	_____

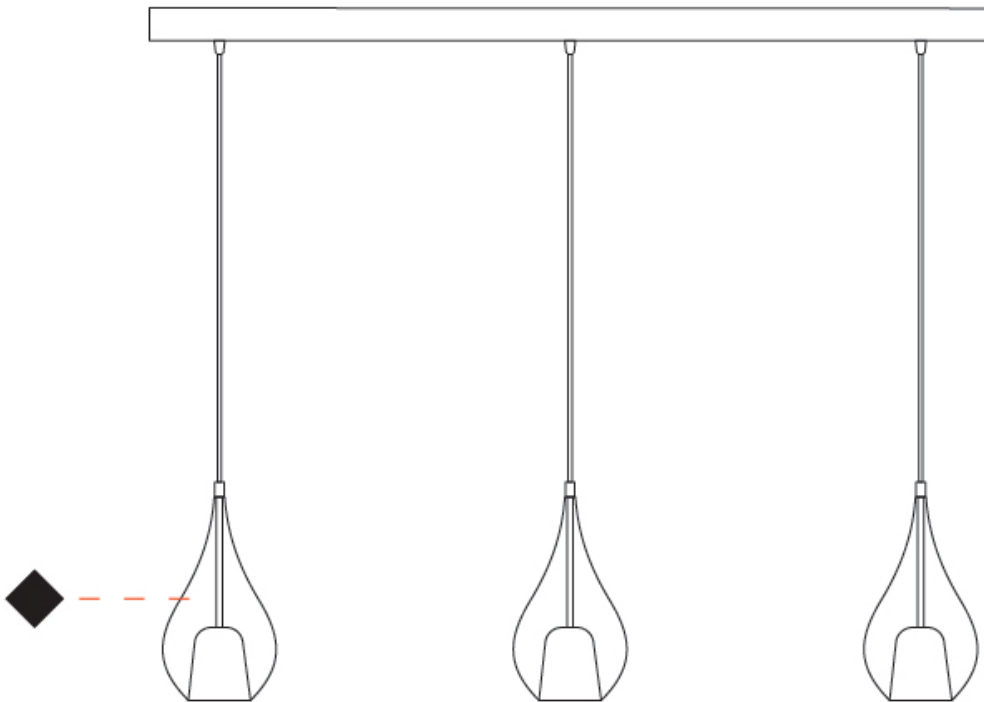

D

ZOE VINCENT 3 LIGHT LINEAR SUSPENSION

D141250-

base number Finish
Options

- To build a product code in our configurator select the specify button on the base model # product page
- To build a manual product code on this datasheet choose from the options listed below in blue font and add the suffix to the base model #

GENERAL

Series: Zoe
Subseries: Zoe Vincent 3 Light Linear
Partner: Cangini & Tucci
Division: Design
Installation: Suspension
Product Type: Pendant
Mounting Location: Ceiling

PHYSICAL

Shape: Teardrop
Length (mm): 1200
Length (in): 47 ¼
Height (mm): 280
Height (in): 11
Max. Overall Height (mm): 1780
Max. Overall Height (in): 70 ⅞
Weight (kg): 5.59
Weight (lbs): 12.32
Diffuser: Glass - Opal
Fixture Finish: [MSB / MBS / TRS](#)
Holder Finish: BLK
Fixture Material: Glass / Metal
Primary Material: Glass - Borosilicate
Cable Details: 1500mm cable

ELECTRICAL

Number of Lamps: 3
Lamp Type: LED Retrofit
Lamp Shape: A19
Bulb Included: Bulb Not Included
Total Output Wattage (W): 48
Max. Wattage Per Lamp (W): 16
Lamp Base: E26
Input Voltage (V): 120
Upon Request: 277Vac / GU24

LED

OPTICAL

RATINGS AND CERTIFICATIONS

Certified By: Certified for North American Standards
IP rating: IP20

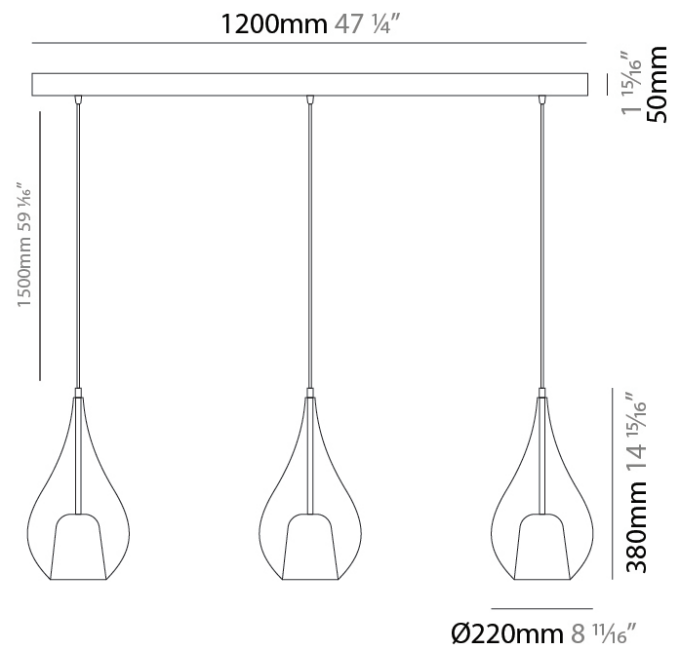

ZOE VINCENT 3 LIGHT LINEAR SUSPENSION

D141250-

PROJECT	_____
TYPE	_____
SPECIFIER	_____
QUANTITY	_____
DATE	_____

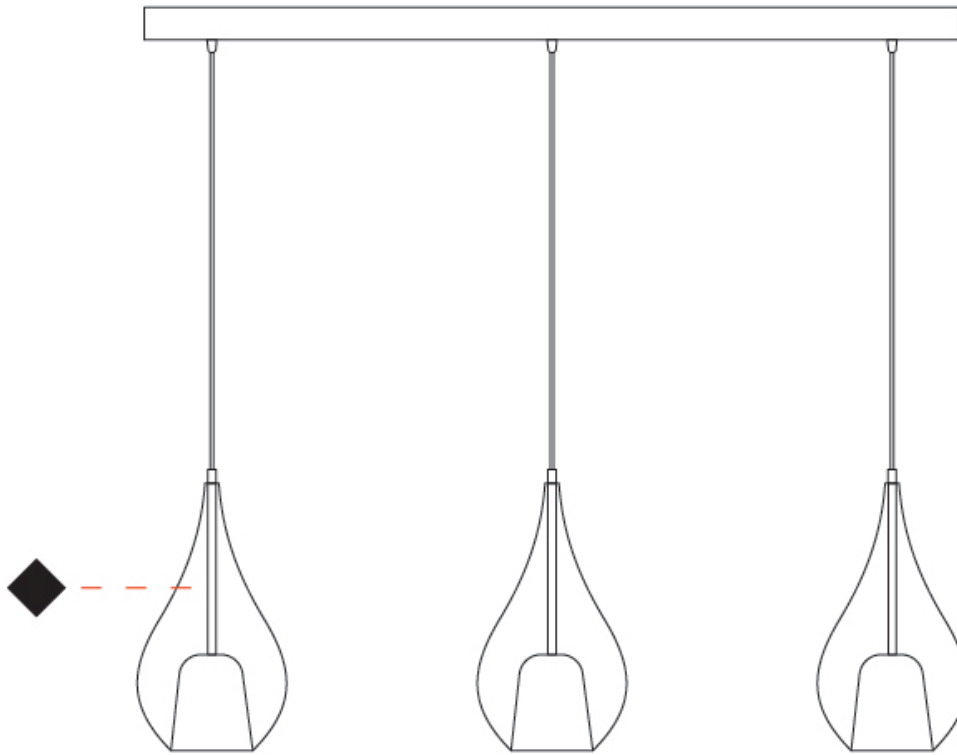

ZOE VINCENT 3 LIGHT CLUSTER SUSPENSION

D141251-

base number Finish
Options

- To build a product code in our configurator select the specify button on the base model # product page
- To build a manual product code on this datasheet choose from the options listed below in blue font and add the suffix to the base model #

GENERAL

Series: Zoe
Subseries: Zoe Vincent 3 Light Cluster
Partner: Cangini & Tucci
Division: Design
Installation: Suspension
Product Type: Pendant
Mounting Location: Ceiling

PHYSICAL

Shape: Teardrop
Diameter (mm): 430
Diameter (in): 16 ¹⁵/₁₆
Height (mm): 1500
Height (in): 59 ¹⁵/₁₆
Weight (kg): 6.48
Weight (lbs): 14.29
Diffuser: Glass - Opal
Fixture Finish: MSB / MBS / TRS
Holder Finish: BLK
Fixture Material: Glass / Metal
Primary Material: Glass - Borosilicate
Cable Details: 1500mm cable

ELECTRICAL

Number of Lamps: 3
Lamp Type: LED Retrofit
Bulb Included: Bulb Not Included
Total Output Wattage (W): 37
Max. Wattage Per Lamp (W): 16 + 5
Lamp Base: E26 + G9
Input Voltage (V): 120

LED

OPTICAL

RATINGS AND CERTIFICATIONS

Certified By: Certified for North American Standards
IP rating: IP20

PROJECT	_____
TYPE	_____
SPECIFIER	_____
QUANTITY	_____
DATE	_____

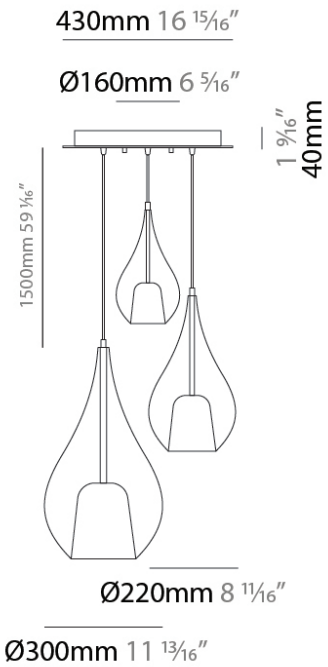

ZOE VINCENT 3 LIGHT CLUSTER SUSPENSION

D141251-

PROJECT

TYPE

SPECIFIER

QUANTITY

DATE

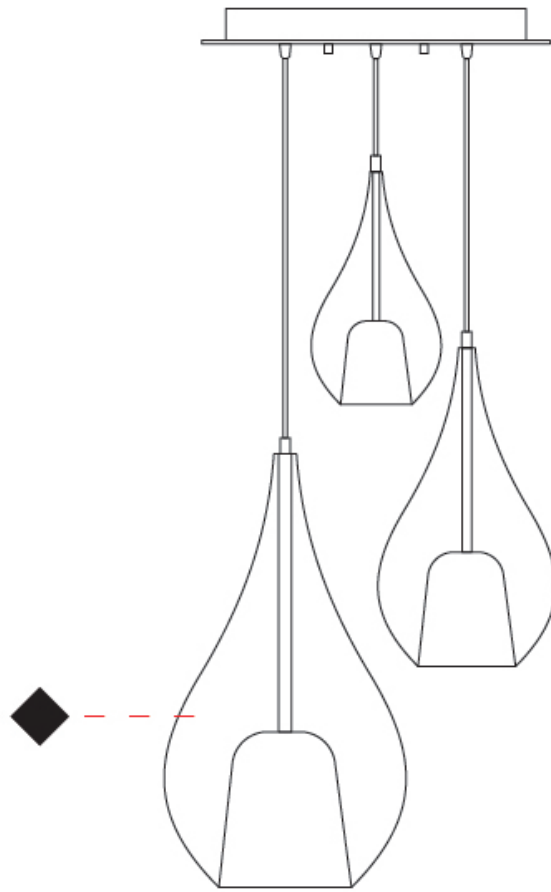

D

PROJECT	_____
TYPE	_____
SPECIFIER	_____
QUANTITY	_____
DATE	_____

ZOE MAX SUSPENSION

D141268- _____ - _____
 base number Finish Finish
 Options Options

- To build a product code in our configurator select the specify button on the base model # product page
- To build a manual product code on this datasheet choose from the options listed below in blue font and add the suffix to the base model #

GENERAL

Series: Zoe
 Subseries: Zoe Max
 Partner: Cangini & Tucci
 Division: Design
 Installation: Suspension
 Product Type: Pendant
 Mounting Location: Ceiling

PHYSICAL

Shape: Teardrop
 Diameter (mm): 450
 Diameter (in): 17 ¾
 Height (mm): 800
 Height (in): 31 ½
 Max. Overall Height (mm): 2300
 Max. Overall Height (in): 90 ½
 Weight (kg): 7.80
 Weight (lbs): 17.19
 Diffuser: Glass - Opal
 Fixture Finish: [AMB / GRN / BRZ / PNK / RUB / SKB / SMK / TOB / TRA / GLD / BLK](#)
 Holder Finish: [CHR / MWH / MBK / BCR](#)
 Fixture Material: Glass / Metal
 Primary Material: Glass - Borosilicate
 Cable Details: 1500mm Cable

ELECTRICAL

Number of Lamps: 1
 Lamp Type: LED Retrofit
 Lamp Shape: A19
 Bulb Included: Bulb Not Included
 Max. Wattage Per Lamp (W): 25
 Lamp Base: E26
 Input Voltage (V): 120
 Upon Request: 277Vac / GU24

LED

OPTICAL

RATINGS AND CERTIFICATIONS

Certified By: Certified for North American Standards
 IP rating: IP20

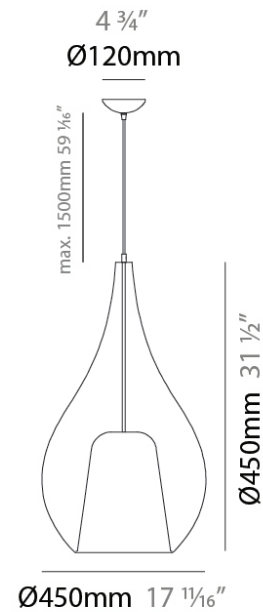

ZOE MAX SUSPENSION

D141268-

PROJECT	_____
TYPE	_____
SPECIFIER	_____
QUANTITY	_____
DATE	_____

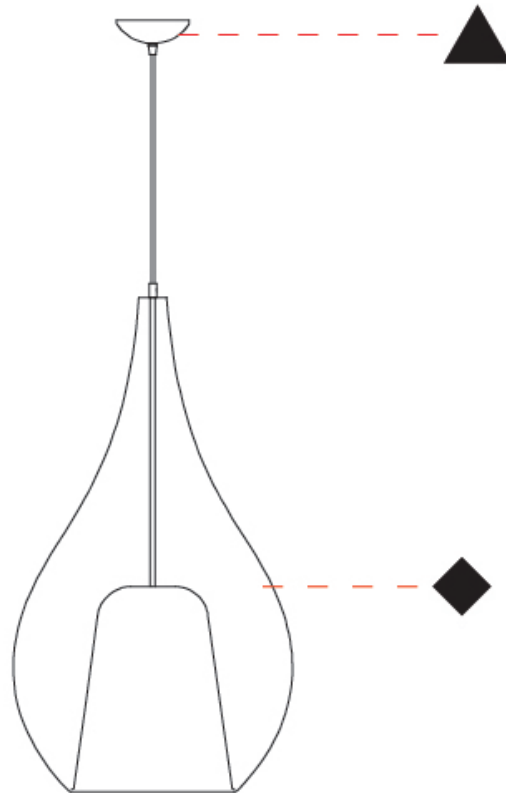

D

ZOE SUSPENSION

D14ZOE-MOD-SYS

base number

1. To build a product code in our configurator select the specify button on the base model # product page
2. To build a manual product code on this datasheet choose from the options listed below in blue font and add the suffix to the base model #

GENERAL

Series: Zoe
Partner: Cangani & Tucci
Division: Design
Installation: Suspension
Product Type: Clusters
Mounting Location: Ceiling

PHYSICAL

ELECTRICAL

Lamp Type: LED Retrofit
Bulb Included: Bulb Not Included
Input Voltage (V): 120

LED

OPTICAL

RATINGS AND CERTIFICATIONS

Certified By: Certified for North American Standards
IP rating: IP20



PROJECT
TYPE
SPECIFIER
QUANTITY
DATE

Fixture Finish

Amber - AMB



Black - BLK



Bronze - BRZ

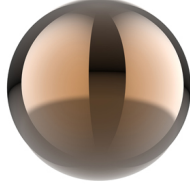

Gold - GLD

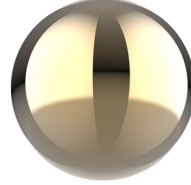

Green - GRN



Pink - PNK



Ruby - RUB



Sky Blue - SKB



Smoke - SMK



Tobacco - TOB



Transparent - TRA



Holder Finish

Black - BLK

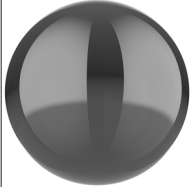

Chrome - CHR



Matte White - MWH

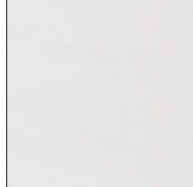

Matte Black - MBK

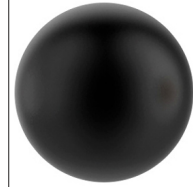



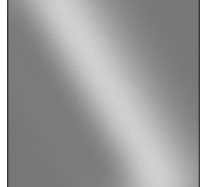

































































Brushed Chrome - BCR













Digital: Not all screens are calibrated the same, and therefore, colors will appear differently between screens.

Physical: When texture is involved, there will be variations in color, character and tone within a product series and between product families.











LEGEND

	floor-mounted		pivotal		special LED (upon request) RGB, RGBW, tunable, gold+, meat+, art+, fashion+
	wall and ceiling: recessed and surface mounted		rotating		warm dim / natural dimming LED
	ceiling-mounted and wall-mounted		illuminate tilted		rechargeable battery powered
	wall-mounted		color of suspension cable		fixture with natural vivid LED (upon request)
	omni-directional light distribution		length of suspension cable		color rendering index
	direct light distribution		reflector degree selection		color temperature
	direct/indirect light distribution		super spot		lumen (luminous flux)
	indirect light distribution		lens		efficacy (lumens per watt)
	asymmetric light distribution		lens pack		Unified Glare Rating (UGR) range from 5-40
	aura light distribution		shine ring		marine grade (AISI 316 stainless steel)
	round wall or ceiling cut-out		integrated shine ring with diffuser		walk on
	square wall or ceiling cut-out		free individual colors 01-29		drive on
	the supplied jig specifies the cutout dimensions		individual colors: 00 (free of charge), 01-25 (extra charge)		Dark Sky Compliance
	minimum distance (meters) lamp - object		luminaire part to be colored (F1)		Americans with Disabilities Act (less than 4" off the wall located between 27"-84" from floor)
	recessed depth		luminaire part to be colored (F2)		lamp protected against explosion
	ceiling thickness in mm		luminaire part to be colored (F3)		blown glass using traditional methods by master glass blower
	ceiling thickness selection		luminaire part to be colored (F4)		acoustic material
	dimmable DP (phase), DV (0-10V), DD (dali), DS (step-dim)		luminaire part to be colored (F5)		protection class I, protection insulation
	included or excluded LED driver/transformer/control gear		color of 3-circuit adaptor		protection class II, protection insulation
	separately switchable		indirect diffuser		ETL Certified to UL and CSA Standards
	sensor		direct diffuser		UL Certified to UL and CSA Standards
	remote control		ball-proof (upon request)		CSA Certified to UL and CSA Standards
	available upon request		accessory		Certified for North American Standards

IP RATING

	protected against ingress of solid bodies greater than 12.5mm (finger)
	protected against ingress of solid bodies greater than 2.5mm protected against sprays of water up to 60 degrees from the vertical (rain)
	protected against ingress of solid bodies greater than 1mm (wire) no protection against the ingress of moisture
	protected against ingress of solid bodies greater than 1mm (wire) protected against sprays of water up to 60 degrees from the vertical (rain)
	protected against ingress of solid bodies greater than 1mm (wire) protected against water splashed from all directions
	protected against limited ingress of dust (wet rooms/covered outdoor areas) protected against water splashed from all directions
	protected against ingress of dust protected against jets of water
	protected against ingress of dust protected against powerful jets of water or heavy seas
	protected against ingress of dust protected against immersion of water between 15cm - 1m for 30 minutes
	protected against ingress of dust protected against immersion of water under pressure for long periods

IK RATING

	protected against 0.14 joules impact (equivalent to 0.25kg mass dropped from 56mm above the surface)
	protected against 0.2 joules impact (equivalent to 0.25kg mass dropped from 80mm above the surface)
	protected against 0.35 joules impact (equivalent to 0.25kg mass dropped from 140mm above the surface)
	protected against 0.5 joules impact (equivalent to 0.25kg mass dropped from 200mm above the surface)
	protected against 0.7 joules impact (equivalent to 0.25kg mass dropped from 280mm above the surface)
	protected against 1 joules impact (equivalent to 0.25kg mass dropped from 400mm above the surface)
	protected against 2 joules impact (equivalent to 0.5kg mass dropped from 400mm above the surface)
	protected against 5 joules impact (equivalent to 1.7kg mass dropped from 300mm above the surface)
	protected against 10 joules impact (equivalent to 5.0kg mass dropped from 200mm above the surface)
	protected against 20 joules impact (equivalent to 5.0kg mass dropped from 400mm above the surface)